



kiwa



TIEMME
www.tiemme.com
COPYRIGHT

serie 1400

**RACCORDI A
COMPRESSIONE
PER TUBO
"COBRA-PEX"**

**COMPRESSION
FITTINGS FOR
"COBRA-PEX" PIPE**

RACCORDI A COMPRESSIONE PER TUBO "COBRA-PEX"

COMPRESSION FITTINGS FOR "COBRA-PEX" PIPE



ART. 1400
Raccordo diritto maschio
Straight fitting male

CODICE Code	TIPO Size	SPESSORE Thickness	PREZZO Price €	CONF. Unit/Box
140 0192	12 x 3/8"	1,1	3,12	10/250
140 0139	12 x 3/8"	2,0	2,97	10/250
140 0178	12 x 1/2"	1,1	3,24	10/250
140 0121	12 x 1/2"	2,0	2,01	10/250
140 0170	15 x 3/8"	2,5	2,69	10/250
140 0010	15 x 1/2"	2,5	1,88	10/250
140 0071	15 x 3/4"	2,5	3,40	5/150
140 0187	16 x 1/2"	1,5	2,68	10/250
140 0226*	16 x 3/8"	2,0	2,65	10/250
140 0002	16 x 1/2"	2,0	1,83	10/250
140 0038	16 x 1/2"	2,2	1,87	10/250
140 0115	16 x 1/2"	2,3	1,86	10/250
140 0068	16 x 3/4"	2,0	3,24	5/150
140 0070	16 x 3/4"	2,2	3,06	5/150
140 0008	18 x 1/2"	2,0	2,11	10/200
140 0003	18 x 1/2"	2,5	2,11	10/200
140 0114	18 x 3/4"	2,0	2,95	5/150
140 0041	18 x 3/4"	2,5	2,85	5/150
140 0035	20 x 1/2"	2,0	3,47	5/150
140 0095	20 x 1/2"	2,8	3,66	5/150
140 0014	20 x 3/4"	2,0	3,32	5/130
140 0013	20 x 3/4"	2,8	3,73	5/130
140 0046	22 x 1/2"	3,0	3,68	5/130
140 0005	22 x 3/4"	3,0	3,16	5/120
140 0025	25 x 3/4"	2,3	6,83	5/100
140 0036	25 x 3/4"	3,5	6,04	5/110
140 0047	25 x 1"	2,3	7,13	5/90
140 0108	25 x 1"	3,5	7,21	5/90
140 0125	28 x 3/4"	3,0	10,20	5/80
140 0131	28 x 3/4"	4,0	10,52	5/80
140 0016	28 x 1"	3,0	8,56	5/70
140 0166	28 x 1"	4,0	9,78	5/80
140 0140	32 x 3/4"	3,0	9,86	5/60
140 0012	32 x 1"	3,0	9,78	5/50
140 0065	32 x 1"	4,4	12,93	5/50
140 0133**	32 x 1"1/4	3,0	15,27	5/40

**consegna a richiesta / delivery on request



ART. 1402
Raccordo diritto femmina
Straight fitting female

CODICE Code	TIPO Size	SPESSORE Thickness	PREZZO Price €	CONF. Unit/Box
140 0228*	12 x 3/8"	1,1	3,06	10/250
140 0219	12 X 3/8"	2,0	2,52	10/250
140 0207	12 X 1/2"	1,1	3,12	10/200
140 0132	12 x 1/2"	2,0	2,54	10/200
140 0194	15 x 3/8"	2,5	2,50	10/200
140 0024	15 x 1/2"	2,5	2,12	10/200
140 0103	15 x 3/4"	2,5	3,15	5/150
140 0165	16 x 1/2"	1,5	2,33	10/200
140 0009	16 x 1/2"	2,0	2,06	10/200
140 0064	16 x 1/2"	2,2	2,12	10/200
140 0224	16 x 1/2"	2,3	2,12	10/200
140 0109	16 x 3/4"	2,0	3,10	5/150
140 0151	16 x 3/4"	2,2	3,15	5/150
140 0029	18 x 1/2"	2,0	2,47	10/200
140 0011	18 x 1/2"	2,5	2,24	10/200
140 0153	18 x 3/4"	2,0	3,48	5/120
140 0086	18 x 3/4"	2,5	3,42	5/120
140 0053	20 x 1/2"	2,0	4,29	10/150
140 0092	20 x 1/2"	2,8	4,37	10/150
140 0056	20 x 3/4"	2,0	4,10	5/120
140 0084	20 x 3/4"	2,8	4,31	5/120
140 0067	22 x 1/2"	3,0	4,31	5/120
140 0017	22 x 3/4"	3,0	3,50	5/120
140 0202	22 x 1"	3,0	7,41	5/80
140 0073	25 x 3/4"	2,3	7,80	5/110
140 0096	25 x 3/4"	3,5	7,97	5/110
140 0147	25 x 1"	2,3	9,55	5/80
140 0160	25 x 1"	3,5	8,71	5/90
140 0149	28 x 3/4"	3,0	9,52	5/90
140 0235	28 x 3/4"	4,0	10,40	5/90
140 0050	28 x 1"	3,0	8,53	5/80
140 0182	28 x 1"	4,0	9,78	5/80
140 0209*	32 x 3/4"	3,0	13,01	5/60
140 0042	32 x 1"	3,0	12,97	5/50
140 0162	32 x 1"	4,4	14,49	5/50

* Fino ad esaurimento scorta / until out of stock

RACCORDI A COMPRESSIONE PER TUBO "COBRA-PEX"

COMPRESSION FITTINGS FOR "COBRA-PEX" PIPE



ART. 1401
Raccordo diritto doppio
Straight fitting double

CODICE Code	TIPO Size	SPESORE Thickness	PREZZO Price €	CONF. Unit/Box
140 0157	12 x 12	2,0	3,41	10/200
140 0061	15 x 15	2,5	3,37	10/200
140 0206*	16 x 16	1,5	3,67	10/200
140 0015	16 x 16	2,0	3,33	10/200
140 0118	16 x 16	2,2	3,63	10/200
140 0252	16 x 16	2,3	3,58	10/200
140 0034	18 x 18	2,0	4,03	10/150
140 0022	18 x 18	2,5	3,75	10/150
140 0043	20 x 20	2,0	6,77	5/100
140 0146	20 x 20	2,8	6,98	5/100
140 0030	22 x 22	3,0	6,42	5/100
140 0101	25 x 25	2,3	11,94	5/70
1400148	25 x 25	3,5	12,05	5/70
140 0072	28 x 28	3,0	11,94	5/50
140 0191	28 x 28	4,0	13,04	5/50
140 0051	32 x 32	3,0	16,13	5/35
140 0213	32 x 32	4,4	19,85	5/35



ART. 1403
Raccordo curvo doppio
Elbow double

CODICE Code	TIPO Size	SPESORE Thickness	PREZZO Price €	CONF. Unit/Box
140 0243	12 x 12	1,1	4,84	10/150
140 0195	12 x 12	2,0	4,86	10/150
140 0076	15 x 15	2,5	3,86	10/150
140 0223	16 x 16	1,5	4,46	10/150
140 0021	16 x 16	2,0	4,10	10/150
140 0119	16 x 16	2,2	4,27	10/150
140 0074	18 x 18	2,0	5,38	10/120
140 0039	18 x 18	2,5	5,34	10/120
140 0079	20 x 20	2,0	7,23	5/80
140 0167	20 x 20	2,8	7,42	5/80
140 0057	22 x 22	3,0	7,24	5/70
140 0143	25 x 25	2,3	13,31	5/60
140 0173*	25 x 25	3,5	13,42	5/60
140 0137	28 x 28	3,0	15,19	5/40
140 0168	28 x 28	4,0	16,32	5/40
140 0116	32 x 32	3,0	18,89	5/25
140 0268*	32 x 32	4,4	23,22	5/25



ART. 1411
Raccordo diritto doppio ridotto
Reduced union

CODICE Code	TIPO Size	SPESORE Thickness	PREZZO Price €	CONF. Unit/Box
140 0199*	22x15	3,0/2,5	7,11	5/120
140 0267	22x18	3,0/2,5	7,11	5/100
140 0281*	28 x 22	3,0/3,0	19,30	5/70



ART. 1404
Raccordo curvo maschio
Elbow male

CODICE Code	TIPO Size	SPESORE Thickness	PREZZO Price €	CONF. Unit/Box
140 0218	12 x 1/2"	1,1	3,57	10/200
140 0197	12 x 1/2"	2,0	3,67	10/200
140 0078	15 x 1/2"	2,5	3,11	10/200
140 0155	15 x 3/4"	2,5	4,48	5/120
140 0251*	16 x 1/2"	1,5	3,83	10/200
140 0026	16 x 1/2"	2,0	3,10	10/200
140 0089	16 x 1/2"	2,2	3,12	10/200
140 0124	16 x 3/4"	2,0	4,28	5/130
140 0097	16 x 3/4"	2,2	4,40	5/130
140 0081	18 x 1/2"	2,0	4,74	10/150
140 0052	18 x 1/2"	2,5	4,54	10/150
140 0105	18 x 3/4"	2,5	4,98	5/120
140 0110	20 x 1/2"	2,0	6,13	10/120
140 0176	20 x 1/2"	2,8	6,51	10/120
140 0059	20 x 3/4"	2,0	6,21	5/100
140 0063	20 x 3/4"	2,8	5,34	5/100
140 0019	22 x 3/4"	3,0	9,42	5/90
140 0062	25 x 3/4"	2,3	9,47	5/90
140 0100	25 x 3/4"	3,5	10,26	5/90
140 0093	25 x 1"	2,3	9,57	5/70
140 0161	25 x 1"	3,5	10,02	5/70
140 0129	28 x 1"	3,0	10,57	5/60
140 0215	28 x 1"	4,0	11,94	5/60
140 0234*	32 x 3/4"	3,0	16,28	5/35
140 0098	32 x 1"	3,0	12,83	5/35
140 0179	32 x 1"	4,4	16,96	5/35
140 0128**	32 x 1"1/4	3,0	19,58	5/35

**consegna a richiesta / delivery on request



ART. 1412
Raccordo curvo doppio ridotto
Reduced elbow

CODICE Code	TIPO Size	SPESORE Thickness	PREZZO Price €	CONF. Unit/Box
140 0282*	22 x 15	3,0/2,5	8,45	5/80

* Fino ad esaurimento scorta / until out of stock

RACCORDI A COMPRESSIONE PER TUBO "COBRA-PEX"

COMPRESSION FITTINGS FOR "COBRA-PEX" PIPE



ART. 1405
Raccordo curvo femmina
Elbow female

CODICE Code	TIPO Size	SPESORE Thickness	PREZZO Price €	CONF. Unit/Box
140 0232	12 x 1/2"	1,1	4,27	10/150
140 0177	12 x 1/2"	2,0	3,15	10/150
140 0048	15 x 1/2"	2,5	2,81	10/150
140 0172	15 x 3/4"	2,5	6,20	5/100
140 0237*	16 x 1/2"	1,5	4,54	10/150
140 0006	16 x 1/2"	2,0	2,65	10/150
140 0082	16 x 1/2"	2,2	2,86	10/150
140 0245	16 x 1/2"	2,3	2,93	10/150
140 0154	16 x 3/4"	2,0	4,25	5/100
140 0169	16 x 3/4"	2,2	5,86	5/100
140 0276*	16 x 3/4"	2,3	6,08	5/100
140 0069	18 x 1/2"	2,0	4,25	10/120
140 0033	18 x 1/2"	2,5	3,82	10/120
140 0112	18 x 3/4"	2,5	5,73	5/90
140 0088	20 x 1/2"	2,0	4,83	5/100
140 0180	20 x 1/2"	2,8	4,92	5/100
140 0060	20 x 3/4"	2,0	5,63	5/80
140 0117	20 x 3/4"	2,8	5,89	5/80
140 0135	22 x 1/2"	3,0	5,13	5/90
140 0028	22 x 3/4"	3,0	5,49	5/80
140 0113	25 x 3/4"	2,3	10,53	5/50
1400158	25 x 3/4"	3,5	10,64	5/80
1400181	25 x 1"	2,3	10,64	5/60
140 0277*	25 x 1"	3,5	11,10	5/60
140 0123	28 x 1"	3,0	10,63	5/50
140 0233	28 x 1"	4,0	11,34	5/60
140 0142	32 x 1"	3,0	14,83	5/35
140 0250*	32 x 1"	4,4	15,64	5/35



ART. 1406
Raccordo curvo femmina con flangia
a 3 fori
Wallplate elbow female with 3 holes

CODICE Code	TIPO Size	SPESORE Thickness	PREZZO Price €	CONF. Unit/Box
140 0211	12 x 1/2"	1,1	4,37	10/100
140 0175	12 x 1/2"	2,0	4,28	10/100
140 0077	15 x 1/2"	2,5	3,71	10/100
140 0217	16 x 1/2"	1,5	5,88	10/100
140 0023	16 x 1/2"	2,0	3,89	10/100
140 0094	16 x 1/2"	2,2	4,20	10/100
140 0080	18 x 1/2"	2,0	4,32	5/80
140 0045	18 x 1/2"	2,5	4,00	5/80



ART. 1407
Raccordo a T
Tee

CODICE Code	TIPO Size	SPESORE Thickness	PREZZO Price €	CONF. Unit/Box
140 0229	12 x 12 x 12	1,1	8,62	10/100
140 0163	12 x 12 x 12	2,0	6,19	10/100
140 0049	15 x 15 x 15	2,5	5,34	10/100
140 0156*	16 x 16 x 16	1,5	5,79	10/100
140 0007	16 x 16 x 16	2,0	4,72	10/100
140 0083	16 x 16 x 16	2,2	5,70	10/100
140 0040	18 x 18 x 18	2,0	7,41	5/60
140 0018	18 x 18 x 18	2,5	7,04	5/60
140 0075	20 x 20 x 20	2,0	9,56	5/50
140 0138	20 x 20 x 20	2,8	10,44	5/50
140 0055	22 x 22 x 22	3,0	9,35	5/40
140 0145	25 x 25 x 25	2,3	19,34	5/35
140 0216	25 x 25 x 25	3,5	19,34	5/35
140 0104	28 x 28 x 28	3,0	20,98	5/25
140 0214*	28 x 28 x 28	4,0	23,30	5/25
140 0111	32 x 32 x 32	3,0	27,13	5/15
140 0256*	32 x 32 x 32	4,4	30,39	5/15



ART. 1413
Raccordo a T ridotto
Reduced tee

CODICE Code	TIPO Size	SPESORE Thickness	PREZZO Price €	CONF. Unit/Box
140 0283*	15 x 22 x 15	2,5/3,0/2,5	11,34	5/60
140 0265*	18 x 15 x 15	2,5/2,5/2,5	9,08	5/70
140 0259*	18 x 15 x 18	2,5/2,5/2,5	9,08	5/70
140 0266*	18 x 18 x 15	2,5/2,5/2,5	9,08	5/70
140 0269	18 x 22 x 18	2,5/3,0/2,5	13,14	5/50
140 0284*	22 x 15 x 15	3,0/2,5/2,5	13,14	5/50
140 0198*	22 x 15 x 22	3,0/2,5/3,0	13,14	5/50
140 0270*	22 x 18 x 18	3,0/2,5/2,5	13,14	5/50
140 0258*	22 x 18 x 22	3,0/2,5/3,0	13,14	5/50
140 0285*	22 x 22 x 15	3,0/3,0/2,5	13,14	5/50
140 0271*	22 x 22 x 18	3,0/3,0/2,5	13,14	5/50

* Fino ad esaurimento scorta / until out of stock

RACCORDI A COMPRESSIONE PER TUBO "COBRA-PEX"

COMPRESSION FITTINGS FOR "COBRA-PEX" PIPE



ART. 1408
Raccordo a T maschio
Tee male

CODICE Code	TIPO Size	SPESSORE Thickness	PREZZO Price €	CONF. Unit/Box
140 0227*	12 x 1/2" x 12	1,1	7,02	10/120
140 0255	12 x 1/2" x 12	2,0	7,02	10/100
140 0188	15 x 1/2" x 15	2,5	6,19	10/100
140 0278*	16 x 1/2" x 16	1,5	6,19	10/100
140 0122	16 x 1/2" x 16	2,0	4,92	10/100
140 0241	16 x 1/2" x 16	2,2	6,08	10/100
140 0279*	16 x 1/2" x 16	2,3	6,35	10/100
140 0184	18 x 1/2" x 18	2,0	6,31	5/80
140 0134	18 x 1/2" x 18	2,5	6,31	5/80
140 0203*	20 x 3/4" x 20	2,0	9,03	5/60
140 0242	20 x 3/4" x 20	2,8	9,23	5/60
140 0231	22 x 1/2" x 22	3,0	8,71	5/60
140 0058	22 x 3/4" x 22	3,0	8,71	5/60
140 0260	25 x 1" x 25	2,3	16,32	5/40
140 0280*	25 x 1" x 25	3,5	16,32	5/40
140 0171	28 x 1" x 28	3,0	18,37	5/30
140 0193	32 x 1" x 32	3,0	23,55	5/20
140 0240*	32 x 1" x 32	4,4	23,55	5/20



ART. 1409
Raccordo a T femmina
Tee female

CODICE Code	TIPO Size	SPESSORE Thickness	PREZZO Price €	CONF. Unit/Box
140 0273*	12 x 1/2" x 12	1,1	7,08	10/100
140 0221	12 x 1/2" x 12	2,0	7,08	10/100
140 0085	15 x 1/2" x 15	2,5	5,18	10/100
140 0263*	16 x 1/2" x 16	1,5	5,18	10/90
140 0020	16 x 1/2" x 16	2,0	4,48	10/90
140 0136	16 x 1/2" x 16	2,2	5,56	10/90
140 0066	18 x 1/2" x 18	2,0	5,91	5/70
140 0037	18 x 1/2" x 18	2,5	5,91	5/70
140 0130	20 x 1/2" x 20	2,0	10,20	5/60
140 0186*	20 x 1/2" x 20	2,8	10,08	5/60
140 0127	20 x 3/4" x 20	2,0	10,81	5/50
140 0208	20 x 3/4" x 20	2,8	10,75	5/50
140 0141	22 x 1/2" x 22	3,0	10,01	5/50
140 0044	22 x 3/4" x 22	3,0	8,90	5/40
140 0152	25 x 3/4" x 25	2,3	16,32	5/40
140 0201	25 x 3/4" x 25	3,5	16,32	5/40
140 0183	28 x 3/4" x 28	3,0	18,46	5/35
140 0099	28 x 1" x 28	3,0	19,16	5/30
140 0196*	28 x 1" x 28	4,0	21,81	5/30
140 0222	32 x 3/4" x 32	3,0	22,33	5/20
140 0249*	32 x 3/4" x 32	4,4	22,33	5/20
140 0107	32 x 1" x 32	3,0	22,33	5/20



ART. 1410
Raccordo a croce
Cross

CODICE Code	TIPO Size	SPESSORE Thickness	PREZZO Price €	CONF. Unit/Box
140 0272*	15x15x15x15	2,5	15,23	5/60
140 0210	18x18x18x18	2,5	16,48	5/60
140 0230	22x22x22x22	3,0	26,07	5/35



ART. 1133
Raccordo curvo doppio
tubo rame / tubo pex
Elbow double copper pipe / pex pipe

CODICE Code	TIPO Size	PREZZO Price €	CONF. Unit/Box
471 0027	22 (Cu)/18 sp. 2,5 (Pex)	vedi cap. 22	5/100
471 0008	22 (Cu)/22 sp. 3,0 (Pex)	vedi cap. 22	5/100



ART. 1138
Raccordo a T tubo rame / tubo
Pex / tubo rame
*Tee copper pipe / Pex pipe
/ copper pipe*

CODICE Code	TIPO Size	PREZZO Price €	CONF. Unit/Box
471 0037	22 (Cu)/18 sp. 2,5 (Pex)/22(Cu)	vedi cap. 22	5/50
471 0025	22 (Cu)/22 sp. 3,0 (Pex)/22(Cu)	vedi cap. 22	5/50

* Fino ad esaurimento scorta / until out of stock

RACCORDI A COMPRESSIONE PER TUBO "COBRA-PEX"

COMPRESSION FITTINGS FOR "COBRA-PEX" PIPE



ART. 1415

Dado
Nut

CODICE Code	TIPO Size	PREZZO Price €	CONF. Unit/Box
140 0286	12	1,07	50/700
140 0244	15	1,07	50/700
140 0212	16	1,07	50/700
140 0246	18	1,43	50/500
140 0253	20	1,70	50/400
140 0254	22	1,70	50/300
140 0257	25	2,34	10/200
140 0287	28	3,41	10/150
140 0288	32	5,16	10/200



ART. 1416

Ogiva in ottone
Brass compression ring

CODICE Code	TIPO Size	PREZZO Price €	CONF. Unit/Box
140 0289	12	0,42	50/2500
140 0106	15	0,52	50/2300
140 0159	16	0,57	50/2300
140 0236	18	0,64	50/1000
140 0204	20	0,72	50/1200
140 0185	22	0,75	50/1400
140 0225	25	1,96	50/800
140 0238	28	2,01	50/700
140 0220	32	2,19	10/400



ART. 1450

Raccordo diritto maschio 1/2" con
O-Ring, tubo PE-X per collettori barra
Straight fitting male PE-X pipe with
O-Ring for bar manifolds

CODICE Code	TIPO Size	PREZZO Price €	CONF. Unit/Box
140 0239	16 x 2,0	vedi cap. 17	10/250
140 0090	16 x 2,2	vedi cap. 17	10/250
140 0248*	20 x 2,0	vedi cap. 17	5/150
140 0174	20 x 2,8	vedi cap. 17	5/150

* Fino ad esaurimento scorta/ until out of stock

RACCORDI A COMPRESSIONE PER TUBO "COBRA-PEX"

COMPRESSION FITTINGS FOR "COBRA-PEX" PIPE



ART. 1428MP

Interasse fori fissaggio = 34 mm
Interaxis fixing hole = 34 mm

Raccordo curvo 105° femmina
105° Elbow female



ART. 1428XL

Raccordo curvo 105° femmina-lungo
105° long elbow female

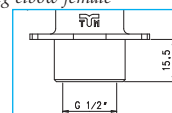

CODICE Code	TIPO Size	SPESSORE Thickness	PREZZO Price €	CONF. Unit/Box
140 0164	12 x 1/2"	1,1	4,05	10/120
140 0054	12 x 1/2"	2,0	4,03	10/120
140 0150**	15 x 1/2"	tutti/all	3,30	10/120
140 0027	15 x 1/2"	2,5	4,01	10/120
140 0126**	16 x 1/2"	tutti/all	3,27	10/120
140 0001	16 x 1/2"	2,0	3,05	10/120
140 0004	16 x 1/2"	2,2	3,05	10/120
140 0102	18 x 1/2"	2,0	5,93	10/100
140 0091	18 x 1/2"	2,5	5,93	10/100
140 0032	20 x 1/2"	2,0	5,04	5/100
140 0031	20 x 1/2"	2,8	4,85	5/100

CODICE Code	TIPO Size	SPESSORE Thickness	PREZZO Price €	CONF. Unit/Box
140 0247*	12 x 1/2"	2,0	6,03	10/100
140 0087*	16 x 1/2"	2,0	5,49	10/100
140 0120	16 x 1/2"	2,2	5,34	10/100

* Fino ad esaurimento scorta / until out of stock

** raccordo in esecuzione senza portagomma per connessione tubo vedi GUIDA ALLE CONNESSIONI (vedi sotto) e cap. 12 WATERBLOCK/cap. 18 COLLETTORI DI DISTRIBUZIONE fittings without hose connection for pipe connection see CONNECTION GUIDE (see below) and chap. 12 WATERBLOCK/chap. 18 MANIFOLDS

ART. 140 0126

GUIDA ALLE CONNESSIONI CONNECTION GUIDE

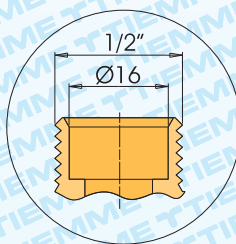
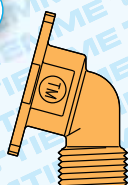

Art. 1435
Per tubo Pe-x
For Pe-x pipe



Art. 1635
Per tubo multistrato
For multilayer pipe



Art. 1240
Per tubo rame
For copper pipe

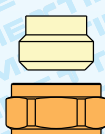

**Art. 1233
Art. 1235**
Per tubo rame
For copper pipe

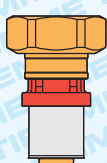

Art. 1668
Per tubo multistrato
For multilayer pipe



Art. 144 0063
Tappo
Cap

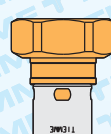

Art. 1716
Per tubo Pe-x
For Pe-x pipe

ART. 140 0150

GUIDA ALLE CONNESSIONI CONNECTION GUIDE

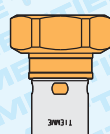
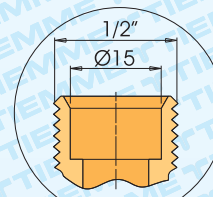

Art. 1717
Per tubo Pe-x
For Pe-x pipe

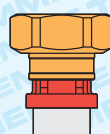

Art. 1694
Per tubo multistrato
For multilayer pipe



Art. 1631
Per tubo multistrato
For multilayer pipe



Art. 1149
Per tubo Pe-x
For Pe-x pipe

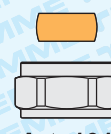

**Art. 1014
Art. 1015**
Per tubo rame
For copper pipe

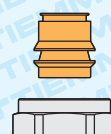

**Art. 1147
Art. 1014**
Per tubo rame
For copper pipe

RACCORDI A COMPRESSIONE PER TUBO "COBRA-PEX" CON BARRIERA ANTI-OSSIGENO
COMPRESSION FITTINGS FOR EVOH "COBRA-PEX" PIPE



ART. 1400AD
 Raccordo diritto maschio
Straight fitting male

CODICE Code	TIPO Size	SPESSORE Thickness	PREZZO Price €	CONF. Unit/Box
141 0007	14 x 1/2"	2,0	2,56	10/250
141 0014	16 x 1/2"	2,0	2,27	10/250
141 0002	17 x 1/2"	2,0	2,51	10/200
141 0017	20 x 1/2"	2,0	4,22	5/150
141 0011	20 x 3/4"	2,0	4,14	5/130



ART. 1401AD
 Raccordo diritto doppio
Straight fitting double

CODICE Code	TIPO Size	SPESSORE Thickness	PREZZO Price €	CONF. Unit/Box
141 0003	14 x 14	2,0	4,03	10/200
141 0010	16 x 16	2,0	4,16	10/200
141 0001	17 x 17	2,0	4,78	10/150
141 0016	18 x 18	2,0	4,78	10/150
141 0009	20 x 20	2,0	7,92	5/100



ART. 1402AD
 Raccordo diritto femmina
Straight fitting female

CODICE Code	TIPO Size	SPESSORE Thickness	PREZZO Price €	CONF. Unit/Box
141 0026	16 x 1/2"	2,0	2,69	10/200
141 0013	17 x 1/2"	2,0	2,58	10/200



ART. 1403AD
 Raccordo curvo doppio
Elbow double

CODICE Code	TIPO Size	SPESSORE Thickness	PREZZO Price €	CONF. Unit/Box
141 0029	14 x 14	2,0	5,29	10/150
141 0034*	16 x 16	2,0	4,98	10/150



ART. 1404AD
 Raccordo curvo maschio
Elbow male

CODICE Code	TIPO Size	SPESSORE Thickness	PREZZO Price €	CONF. Unit/Box
141 0023*	16 x 1/2"	2,0	3,82	10/200
141 0022	17 x 1/2"	2,0	4,68	10/150
141 0006*	20 x 1/2"	2,0	7,26	10/120



ART. 1405AD
 Raccordo curvo femmina
Elbow female

CODICE Code	TIPO Size	SPESSORE Thickness	PREZZO Price €	CONF. Unit/Box
141 0036	14 x 1/2"	2,0	3,38	10/150
141 0008	17 x 1/2"	2,0	4,56	10/120

* Fino ad esaurimento scorta/ until out of stock

RACCORDI A COMPRESSIONE PER TUBO "COBRA-PEX" CON BARRIERA ANTI-OSSIGENO
COMPRESSION FITTINGS FOR EVOH "COBRA-PEX" PIPE



ART. 1406AD
 Raccordo curvo femmina con flangia a 3 fori
Wallplate elbow female with 3 holes

CODICE Code	TIPO Size	SPESSORE Thickness	PREZZO Price €	CONF. Unit/Box
141 0030	14 x 1/2"	2,0	4,73	10/100
141 0015	16 x 1/2"	2,0	4,73	10/100
141 0004	17 x 1/2"	2,0	4,88	5/80



ART. 1407AD
 Raccordo a T
Tee

CODICE Code	TIPO Size	SPESSORE Thickness	PREZZO Price €	CONF. Unit/Box
141 0038	14 x 14 x 14	2,0	6,82	10/100
141 0018*	16 x 16 x 16	2,0	6,82	10/100
141 0039*	17 x 17 x 17	2,0	8,32	5/60



ART. 1409AD
 Raccordo a T femmina
Tee female

CODICE Code	TIPO Size	SPESSORE Thickness	PREZZO Price €	CONF. Unit/Box
141 0041	14 x 1/2" x 14	2,0	7,39	10/100
141 0020	17 x 1/2" x 17	2,0	7,15	5/70



ART. 1415AD
 Dado
Nut

CODICE Code	TIPO Size	PREZZO Price €	CONF. Unit/Box
141 0042	14	1,48	50/700
141 0043	16	1,48	50/700
141 0044	18	1,67	50/500
141 0045	20	2,00	50/400



ART. 1416AD
 Ogiva
Brass compression ring

CODICE Code	TIPO Size	PREZZO Price €	CONF. Unit/Box
141 0028	14	0,52	50/2500
141 0031	16	0,57	50/2300
141 0046	17	0,58	50/1500
141 0027	18	0,64	50/2000
141 0012	20	0,72	50/1500



ART. 1418AD
 Raccordo curvo 105° femmina
105° elbow female

CODICE Code	TIPO Size	SPESSORE Thickness	PREZZO Price €	CONF. Unit/Box
141 0005	16 x 1/2"	2,0	5,94	10/100

* Fino ad esaurimento scorta/ until out of stock

**ACCESSORI PER RACCORDI A COMPRESSIONE PER TUBO "COBRA-PEX"
ACCESSORIES FOR COMPRESSION FITTINGS FOR "COBRA-PEX" PIPE**



ART. 1481

Per art. 1406-1406AD
For art. 1406-1406AD-1656DF
Staffa per curve flangiate
Bracket for wallplate elbow

CODICE Code	TIPO Size	PREZZO Price €	CONF. Unit/Box
147 0005	unica - single	2,12	1/100



ART. 1491

Staffa doppia frazionabile
Double divisible bracket

Per art. 1490-1490P43
For art. 1490-1490P43

CODICE Code	TIPO Size	PREZZO Price €	CONF. Unit/Box
147 0004	unica - single	3,55	1/150



ART. 1490P43

Box plastica per art. 1418-1428MP
Plastic box ART. 1418-1428MP

CODICE Code	TIPO Size	PREZZO Price €	CONF. Unit/Box
147 0008	PER GUAINA Ø 23 SHEATH	2,09	1/100
147 0001	PER GUAINA Ø 27 SHEATH	1,93	1/100

Altezza box / Box height H=59 mm



ART. 1492MP

Box in plastica pareti sottili per art. 1428MP
Plastic box thin walls for art. 1428MP

CODICE Code	TIPO Size	PREZZO Price €	CONF. Unit/Box
147 0002	TAPPO Ø GUAINA 23 CAP Ø SHEATH 23	1,89	1/100

Altezza box / Box height H=46 mm



ART. 1490

Box plastica divisibile per art. 1428MP
Divisible plastic box for art. 1428MP

CODICE Code	TIPO Size	PREZZO Price €	CONF. Unit/Box
147 0003	PER GUAINA Ø 23 E 27 for sheath Ø 23 and 27	2,06	1/90

Altezza box / Box height H=55 mm

Art. 1490

Art. 1418 - 1428

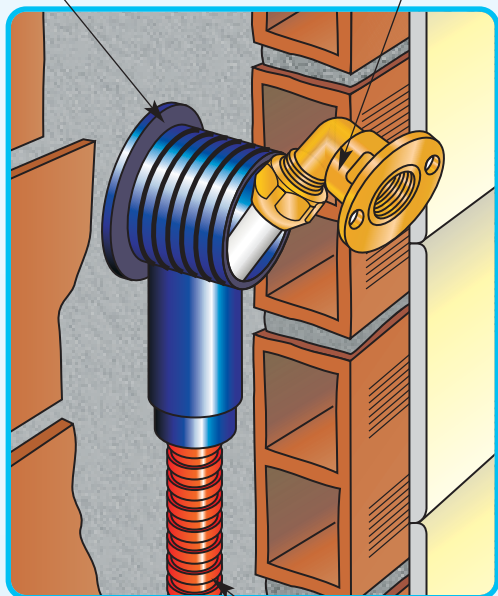

Tubo COBRA-PEX Art. 0800R
COBRA-PEX pipe Art. 0800R

ACCESSORI PER RACCORDI A COMPRESSIONE PER TUBO "COBRA-PEX"

ACCESSORIES FOR COMPRESSION FITTINGS FOR "COBRA-PEX" PIPE



ART. 1420K
Raccordo curvo femmina con attacco 24x19 fil (Ø 18) da utilizzare con box 1420P
Elbow female with 24x19 tpi (Ø 18) adaptor connection to be used with box type 1420P

CODICE Code	TIPO Size	PREZZO Price €	CONF. Unit/Box
140 0190	1/2"- 24x19 fil (Ø 18)	2,85	10/100



ART. 1420K (PEX)
Raccordo curvo femmina con attacco per tubo pex da utilizzare con box 1420P
Elbow female with PEX pipe connection to be used with plastic box 1420P

CODICE Code	TIPO Size	PREZZO Price €	CONF. Unit/Box
140 0200	15 sp 2,5 - 1/2"	4,80	10/100
140 0144	16 sp 2,0 - 1/2"	4,84	10/100
140 0189	18 sp 2,0 - 1/2"	5,15	10/100
140 0205	18 sp 2,5 - 1/2"	5,17	10/100



ART. 1420P
Box in plastica per art.1420K
Plastic box for art. 1420K

CODICE Code	TIPO Size	PREZZO Price €	CONF. Unit/Box
147 0006	per guaina Ø 23 e Ø 27 for sheath Ø 23 and Ø 27	2,90	1/50



ART. 1420Z
Staffa doppia per fissaggio box art. 1420P
Steel bracket to fix plastic box art. 1420P

CODICE Code	TIPO Size	PREZZO Price €	CONF. Unit/Box
147 0007	int. 38, 50 o/ or 100	5,56	1/100
147 0009	int. 38 o/ or 150	5,16	1/100



ART. 1505C04
Tubetto in rame cromato per collegamento elementi radianti
Chrome plated copper tube for radiators connection

CODICE Code	TIPO Size	PREZZO Price €	CONF. Unit/Box
337 0001	Ø15 x 1/2" L=150 mm	7,99	2/60

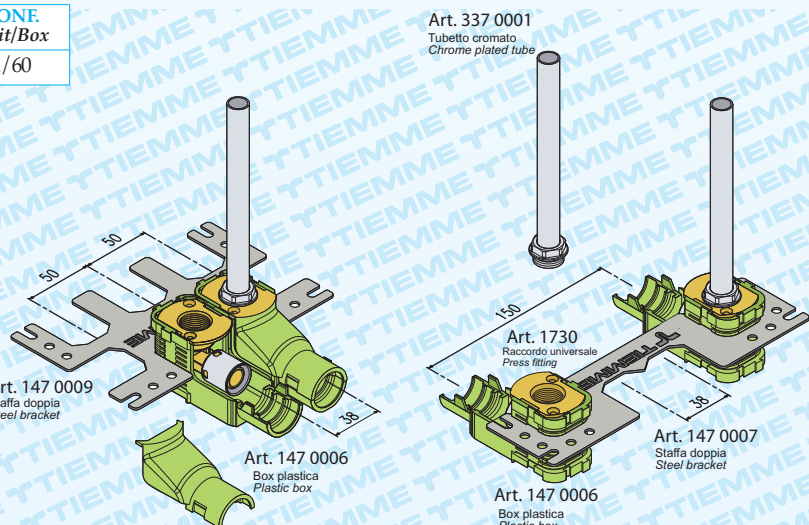

ART. 1420K - 1420KPEX

GUIDA ALLE CONNESSIONI / CONNECTION GUIDE

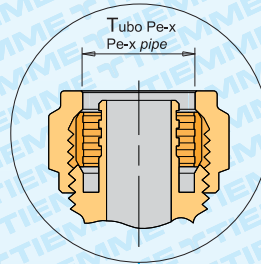
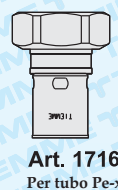
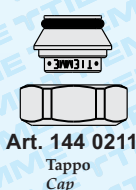
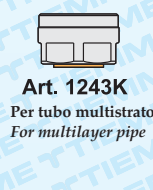
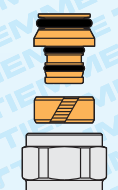
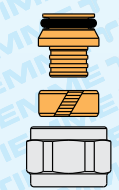
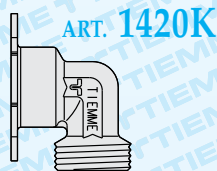
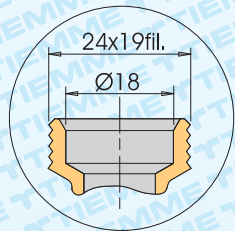

ART. 1420K (PEX)

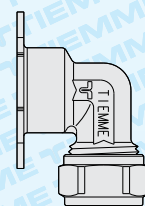

Per tubo Pe-x
For Pe-x pipe

RACCORDI A COMPRESSIONE PER TUBO "COBRA-PEX"

COMPRESSION FITTINGS FOR "COBRA-PEX" PIPE



TABELLA FILETTATURE DADI/THREADS TABLE FOR NUTS

A	10	12	14	15	16	17	18	20	22	25	28	32
B	G 3/8"	G 1/2"	G 1/2"	G 1/2"	G 1/2"	M24 x 1,5	M24 x 1,5	G 3/4"	M28 x 1,5	M32 x 1,5	M36 x 1,5	M42 x 1,5

TABELLA DI SERRAGGIO DADO - n. giri/NUT TIGHTENINGS TABLE - n. turns

A	10	12	14	15	16	17	18	20	22	25	28	32
N.GIRI/TURNS	1	1	1	1	1	1	1	1	1	1	1	1

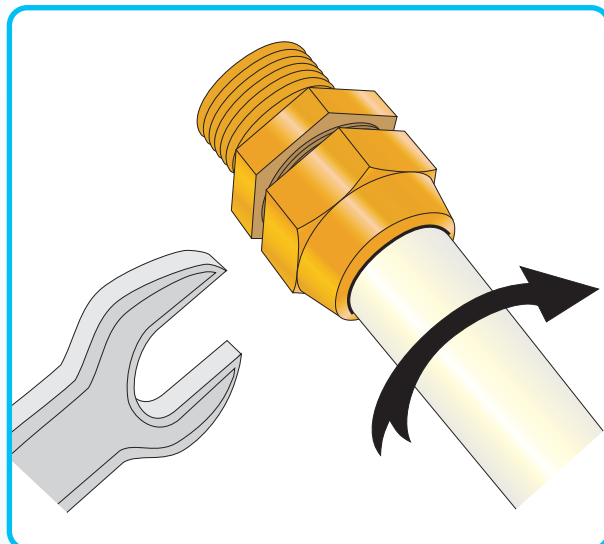
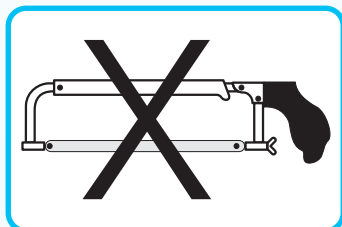
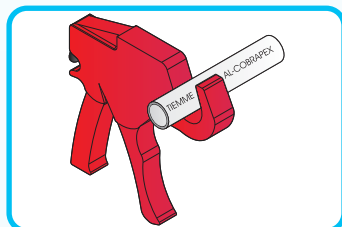
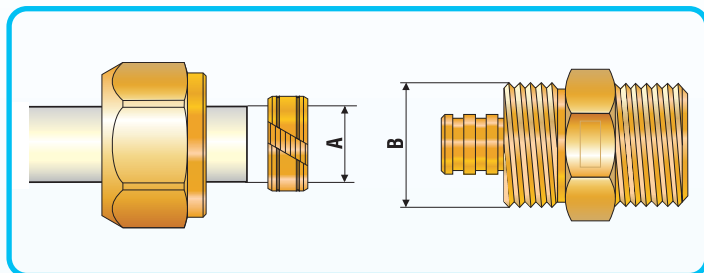
ISTRUZIONI PER IL CORRETTO MONTAGGIO

TAGLIO DEL TUBO

Il taglio del tubo Pe-x deve essere eseguito con appositi strumenti che consentono un taglio senza bave e perfettamente perpendicolare all'asse del tubo.

SBAVATURA E PULITURA DEL TUBO

Sbavare bene il tubo e pulirlo per eliminare eventuali trucioli residui.

MONTAGGIO DEL RACCORDO

Infilare dado e ogiva sul tubo e quest'ultimo sul portagomma del raccordo. Avvitare il dado a mano per quanto consentito, poi in base alla misura del tubo Pe-x chiudere con chiave come da tabella.

INSTRUCTIONS FOR THE CORRECT ASSEMBLING

PIPE CUTTING

Use the suitable instruments which allow a precise cut, perpendicular and without any trimming.

PIPE CLEANING

Clear the pipe carefully in order to remove any remaining trimming.

ASSEMBLING OF THE FITTING

Put the nut and the ring on the pipe, then fit this on the hose end. Tighten the nut by hand as much as is possible then use a spanner following the above table.