



# 24

**NEW**



# TIEMME

[www.tiemme.com](http://www.tiemme.com)

# COPYRIGHT

04284064

Large Battery



**SISTEMI DI  
CONTABILIZZAZIONE**

**CONSUMPTION  
METERING SYSTEM**

# MODULI DI CONTABILIZZAZIONE "VARIO" "VARIO" METERING CONSUMPTION MODULES



**ART. 6500C01**  
Cassetta metallica pre-installazione  
"VARIO"  
"VARIO" metallic box for system  
washing/testing

| CODICE<br>Code | TIPO<br>Size    | PREZZO<br>Price € | CONF.<br>Unit/Box |
|----------------|-----------------|-------------------|-------------------|
| 650 0001       | 640x640x120±170 | 290,20            | 1/1               |

Tronchetti non inclusi / pipes not included



**ART. 6500T**  
Tronchetti provvisori  
Pipes for system washing/testing

| CODICE<br>Code | TIPO<br>Size | PREZZO<br>Price € | CONF.<br>Unit/Box |
|----------------|--------------|-------------------|-------------------|
| 651 0080       | "VARIO"      | 6,25              | 1/10              |



**ART. 6500P02**  
Modulo di contabilizzazione con  
valvola a 2 vie montato su piastra  
Measuring consumption module with  
2-ways valve assembled on plate

| CODICE<br>Code | TIPO<br>Size        | PREZZO<br>Price € | CONF.<br>Unit/Box |
|----------------|---------------------|-------------------|-------------------|
| 650 0002       | 4 - 15 l/min * (L)  | 1.233,37          | 1/1               |
| 650 0003       | 8 - 30 l/min * (L)  | 1.233,37          | 1/1               |
| 650 0004       | 10 - 40 l/min * (L) | 1.233,37          | 1/1               |
| 650 0005       | 4 - 15 l/min * (R)  | 1.306,19          | 1/1               |
| 650 0006       | 8 - 30 l/min * (R)  | 1.306,19          | 1/1               |
| 650 0007       | 10 - 40 l/min * (R) | 1.306,19          | 1/1               |



**ART. 6500P03**  
Modulo di contabilizzazione con  
valvola a 3 vie montato su piastra  
Measuring consumption module with  
3-ways valve assembled on plate

| CODICE<br>Code | TIPO<br>Size        | PREZZO<br>Price € | CONF.<br>Unit/Box |
|----------------|---------------------|-------------------|-------------------|
| 650 0008       | 4 - 15 l/min * (L)  | 1.277,95          | 1/1               |
| 650 0009       | 8 - 30 l/min * (L)  | 1.277,95          | 1/1               |
| 650 0010       | 10 - 40 l/min * (L) | 1.277,95          | 1/1               |
| 650 0011       | 4 - 15 l/min * (R)  | 1.361,94          | 1/1               |
| 650 0012       | 8 - 30 l/min * (R)  | 1.361,94          | 1/1               |
| 650 0013       | 10 - 40 l/min * (R) | 1.361,94          | 1/1               |



**ART. 6500C02**  
Modulo di contabilizzazione con  
valvola a 2 vie montato in cassetta  
Measuring consumption module with  
2-ways valve assembled on metallic  
box complete

| CODICE<br>Code | TIPO<br>Size        | PREZZO<br>Price € | CONF.<br>Unit/Box |
|----------------|---------------------|-------------------|-------------------|
| 650 0014       | 4 - 15 l/min * (L)  | 1.708,43          | 1/1               |
| 650 0015       | 8 - 30 l/min * (L)  | 1.708,43          | 1/1               |
| 650 0016       | 10 - 40 l/min * (L) | 1.708,43          | 1/1               |
| 650 0017       | 4 - 15 l/min * (R)  | 1.811,33          | 1/1               |
| 650 0018       | 8 - 30 l/min * (R)  | 1.811,33          | 1/1               |
| 650 0019       | 10 - 40 l/min * (R) | 1.811,33          | 1/1               |



**ART. 6500C03**  
Modulo di contabilizzazione con  
valvola a 3 vie montato in cassetta  
Measuring consumption module with  
3-ways valve assembled on metallic  
box complete

| CODICE<br>Code | TIPO<br>Size        | PREZZO<br>Price € | CONF.<br>Unit/Box |
|----------------|---------------------|-------------------|-------------------|
| 650 0020       | 4 - 15 l/min * (L)  | 1.716,18          | 1/1               |
| 650 0021       | 8 - 30 l/min * (L)  | 1.716,18          | 1/1               |
| 650 0022       | 10 - 40 l/min * (L) | 1.716,18          | 1/1               |
| 650 0023       | 4 - 15 l/min * (R)  | 1.789,69          | 1/1               |
| 650 0024       | 8 - 30 l/min * (R)  | 1.789,69          | 1/1               |
| 650 0025       | 10 - 40 l/min * (R) | 1.789,69          | 1/1               |

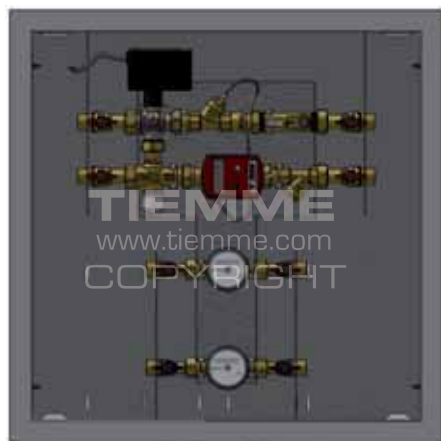

650 0001 + 651 0080

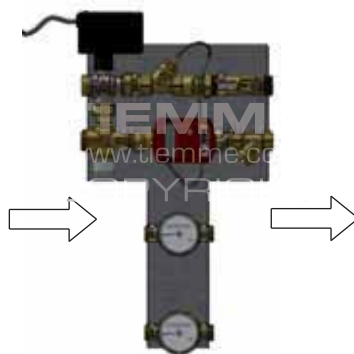

6500P03



\* campo regolazione flussimetro  
balancing valve regulation

(L) strumentazione con lettura locale / direct reading meters  
(R) strumentazione con predisposizione per lettura remota / remote reading meters

# MODULI DI CONTABILIZZAZIONE "FLOOR"

## "FLOOR" METERING CONSUMPTION MODULES



**ART. 6501C01**  
Cassetta metallica pre-installazione "FLOOR"  
"FLOOR" metallic box for system washing/testing

| CODICE<br>Code | TIPO<br>Size    | PREZZO<br>Price € | CONF.<br>Unit/Box |
|----------------|-----------------|-------------------|-------------------|
| 650 0026       | 850x670x120±170 | 472,49            | 1/1               |

Tronchetti non inclusi / pipes not included



**ART. 6500T**  
Tronchetti provvisori  
Pipes for system washing/testing

| CODICE<br>Code | TIPO<br>Size | PREZZO<br>Price € | CONF.<br>Unit/Box |
|----------------|--------------|-------------------|-------------------|
| 651 0081       | "FLOOR"      | 53,25             | 1/10              |



**ART. 6501G02**  
Modulo di contabilizzazione con valvola a 2 vie  
Measuring consumption module with 2-ways valve

| CODICE<br>Code | TIPO<br>Size        | PREZZO<br>Price € | CONF.<br>Unit/Box |
|----------------|---------------------|-------------------|-------------------|
| 650 0027       | 4 - 15 l/min * (L)  | 1.496,98          | 1/1               |
| 650 0028       | 8 - 30 l/min * (L)  | 1.496,98          | 1/1               |
| 650 0029       | 10 - 40 l/min * (L) | 1.496,98          | 1/1               |
| 650 0030       | 4 - 15 l/min * (R)  | 1.574,99          | 1/1               |
| 650 0031       | 8 - 30 l/min * (R)  | 1.574,99          | 1/1               |
| 650 0032       | 10 - 40 l/min * (R) | 1.574,99          | 1/1               |



**ART. 6501G03**  
Modulo di contabilizzazione con valvola a 3 vie  
Measuring consumption module with 3-ways valve

| CODICE<br>Code | TIPO<br>Size        | PREZZO<br>Price € | CONF.<br>Unit/Box |
|----------------|---------------------|-------------------|-------------------|
| 650 0033       | 4 - 15 l/min * (L)  | 1.505,82          | 1/1               |
| 650 0034       | 8 - 30 l/min * (L)  | 1.505,82          | 1/1               |
| 650 0035       | 10 - 40 l/min * (L) | 1.505,82          | 1/1               |
| 650 0036       | 4 - 15 l/min * (R)  | 1.634,60          | 1/1               |
| 650 0037       | 8 - 30 l/min * (R)  | 1.634,60          | 1/1               |
| 650 0038       | 10 - 40 l/min * (R) | 1.634,60          | 1/1               |



**ART. 6501C02**  
Modulo di contabilizzazione con valvola a 2 vie montato in cassetta  
Measuring consumption module with 2-ways valve assembled on metallic box complete

| CODICE<br>Code | TIPO<br>Size        | PREZZO<br>Price € | CONF.<br>Unit/Box |
|----------------|---------------------|-------------------|-------------------|
| 650 0039       | 4 - 15 l/min * (L)  | 1.968,48          | 1/1               |
| 650 0040       | 8 - 30 l/min * (L)  | 1.968,48          | 1/1               |
| 650 0041       | 10 - 40 l/min * (L) | 1.968,48          | 1/1               |
| 650 0042       | 4 - 15 l/min * (R)  | 2.056,70          | 1/1               |
| 650 0043       | 8 - 30 l/min * (R)  | 2.056,70          | 1/1               |
| 650 0044       | 10 - 40 l/min * (R) | 2.056,70          | 1/1               |



**ART. 6501C03**  
Modulo di contabilizzazione con valvola a 3 vie montato in cassetta  
Measuring consumption module with 3-ways valve assembled on metallic box complete

| CODICE<br>Code | TIPO<br>Size        | PREZZO<br>Price € | CONF.<br>Unit/Box |
|----------------|---------------------|-------------------|-------------------|
| 650 0045       | 4 - 15 l/min * (L)  | 1.996,61          | 1/1               |
| 650 0046       | 8 - 30 l/min * (L)  | 1.996,61          | 1/1               |
| 650 0047       | 10 - 40 l/min * (L) | 1.996,61          | 1/1               |
| 650 0048       | 4 - 15 l/min * (R)  | 2.076,43          | 1/1               |
| 650 0049       | 8 - 30 l/min * (R)  | 2.076,43          | 1/1               |
| 650 0050       | 10 - 40 l/min * (R) | 2.076,43          | 1/1               |

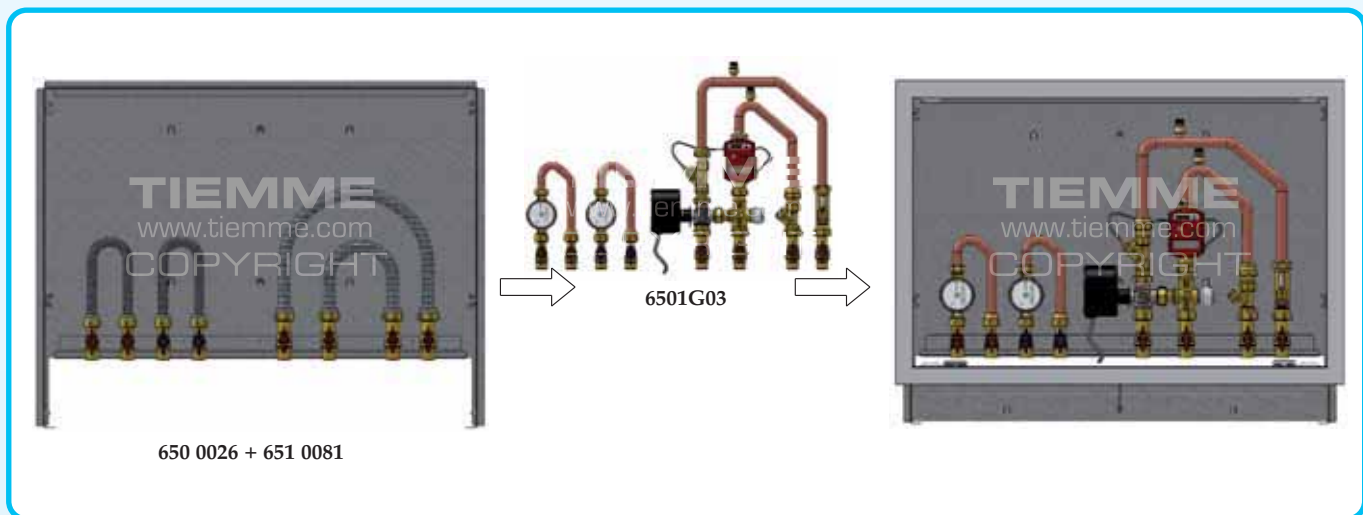

\* campo regolazione flussimetro  
balancing valve regulation

(L) strumentazione con lettura locale / direct reading meters  
(R) strumentazione con predisposizione per lettura remota / remote reading meters

# MODULI DI CONTABILIZZAZIONE "HEAT"

## "HEAT" METERING CONSUMPTION MODULES



**ART. 6503C01**  
Cassetta metallica pre-installazione "HEAT"  
"HEAT" metallic box for system washing/testing

| CODICE<br>Code | TIPO<br>Size    | PREZZO<br>Price € | CONF.<br>Unit/Box |
|----------------|-----------------|-------------------|-------------------|
| 650 0059       | 850x670x120±170 | 503,81            | 1/1               |

Tronchetti non inclusi/pipes not included



**ART. 6500T**  
Tronchetti provvisori  
Pipes for system washing/testing

| CODICE<br>Code | TIPO<br>Size | PREZZO<br>Price € | CONF.<br>Unit/Box |
|----------------|--------------|-------------------|-------------------|
| 651 0082       | "HEAT"       | 103,56            | 1/10              |



**ART. 6503G02**  
Modulo di contabilizzazione con valvola a 2 vie  
Measuring consumption module with 2-ways valve

| CODICE<br>Code | TIPO<br>Size           | PREZZO<br>Price € | CONF.<br>Unit/Box |
|----------------|------------------------|-------------------|-------------------|
| 650 0062       | 35kW - 8-30 l/min* (R) | 2.259,76          | 1/1               |
| 650 0063       | 50kW - 8-30 l/min* (R) | 2.259,76          | 1/1               |



**ART. 6503G03**  
Modulo di contabilizzazione con valvola a 3 vie  
Measuring consumption module with 3-ways valve

| CODICE<br>Code | TIPO<br>Size           | PREZZO<br>Price € | CONF.<br>Unit/Box |
|----------------|------------------------|-------------------|-------------------|
| 650 0064       | 35kW - 8-30 l/min* (R) | 2.273,14          | 1/1               |
| 650 0065       | 50kW - 8-30 l/min* (R) | 2.273,14          | 1/1               |



**ART. 6503C02**  
Modulo di contabilizzazione con valvola a 2 vie montato in cassetta  
Measuring consumption module with 2-ways valve assembled on metallic box complete

| CODICE<br>Code | TIPO<br>Size           | PREZZO<br>Price € | CONF.<br>Unit/Box |
|----------------|------------------------|-------------------|-------------------|
| 650 0066       | 35kW - 8-30 l/min* (R) | 2.647,94          | 1/1               |
| 650 0067       | 50kW - 8-30 l/min* (R) | 2.647,94          | 1/1               |



**ART. 6503C03**  
Modulo di contabilizzazione con valvola a 3 vie montato in cassetta  
Measuring consumption module with 3-ways valve assembled on metallic box complete

| CODICE<br>Code | TIPO<br>Size           | PREZZO<br>Price € | CONF.<br>Unit/Box |
|----------------|------------------------|-------------------|-------------------|
| 650 0068       | 35kW - 8-30 l/min* (R) | 2.663,61          | 1/1               |
| 650 0069       | 50kW - 8-30 l/min* (R) | 2.663,61          | 1/1               |

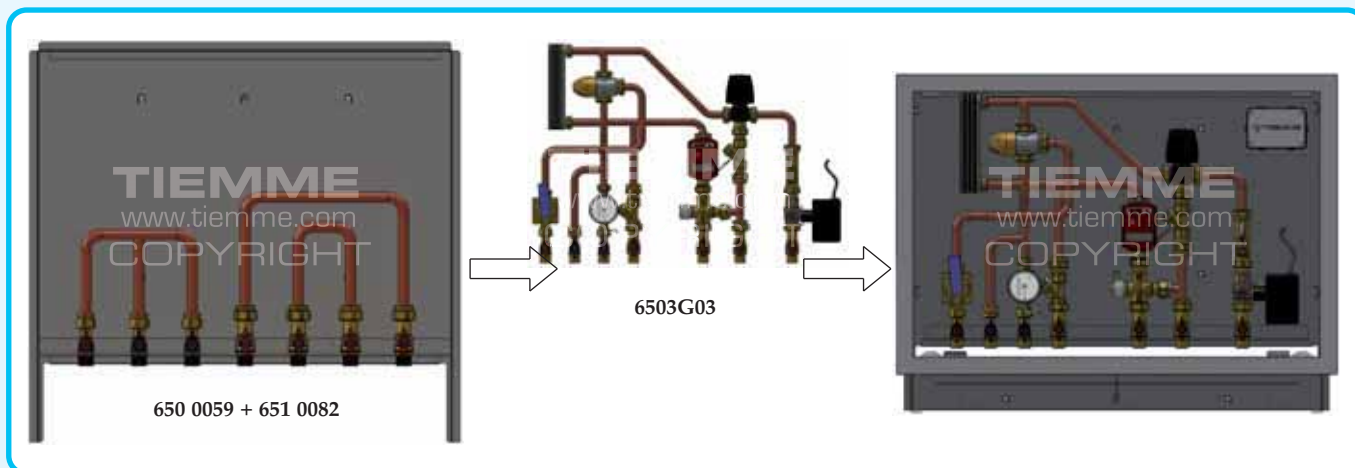

\* campo regolazione flussimetro  
balancing valve regulation

(L) strumentazione con lettura locale / direct reading meters  
(R) strumentazione con predisposizione per lettura remota / remote reading meters

# MODULI DI CONTABILIZZAZIONE "BASIC"

## "BASIC" METERING CONSUMPTION MODULES



### ART. 6510P01

Modulo sanitario assemblato su staffa singola  
Domestic water module assembled on metallic plate

| CODICE<br>Code | TIPO<br>Size       | PREZZO<br>Price € | CONF.<br>Unit/Box |
|----------------|--------------------|-------------------|-------------------|
| 650 0070       | Qn 1,5 m3/h        | 298,21            | 1/1               |
| 650 0071       | Qn 2,5 m3/h        | 328,54            | 1/1               |
| 650 0072       | Qn 1,5 m3/h 1/10** | 378,81            | 1/1               |
| 650 0073       | Qn 2,5 m3/h 1/10** | 400,48            | 1/1               |



### ART. 6511P01

Modulo riscaldamento su staffa singola  
Heating module assembled on metallic plate

| CODICE<br>Code | TIPO<br>Size       | PREZZO<br>Price € | CONF.<br>Unit/Box |
|----------------|--------------------|-------------------|-------------------|
| 650 0074       | Qn 1,5 m3/h        | 310,52            | 1/10              |
| 650 0075       | Qn 2,5 m3/h        | 319,68            | 1/10              |
| 650 0076       | Qn 1,5 m3/h 1/10** | 358,22            | 1/10              |
| 650 0077       | Qn 2,5 m3/h 1/10** | 365,09            | 1/10              |



### ART. 6512P01

Modulo riscaldamento assemblato su staffa singola  
Heating module assembled on metallic plate

| CODICE<br>Code | TIPO<br>Size       | PREZZO<br>Price € | CONF.<br>Unit/Box |
|----------------|--------------------|-------------------|-------------------|
| 650 0078       | Qn 1,5 m3/h        | 917,05            | 1/1               |
| 650 0079       | Qn 2,5 m3/h        | 924,49            | 1/1               |
| 650 0080       | Qn 1,5 m3/h 1/10** | 947,34            | 1/1               |
| 650 0081       | Qn 2,5 m3/h 1/10** | 954,78            | 1/1               |



### ART. 6513P01

Modulo riscaldamento/ACS assemblato su staffa singola  
Heating/DHW module assembled on metallic plate

| CODICE<br>Code | TIPO<br>Size       | PREZZO<br>Price € | CONF.<br>Unit/Box |
|----------------|--------------------|-------------------|-------------------|
| 650 0082       | Qn 1,5 m3/h        | 948,71            | 1/10              |
| 650 0083       | Qn 2,5 m3/h        | 956,12            | 1/10              |
| 650 0084       | Qn 1,5 m3/h 1/10** | 993,17            | 1/10              |
| 650 0085       | Qn 2,5 m3/h 1/10** | 1.000,56          | 1/10              |



### ART. 6500G02

Modulo riscaldamento con valvola a 2 vie "BASIC-HT"  
Heating measuring consumption module with 2-ways valve "BASIC-HT"

| CODICE<br>Code | TIPO<br>Size        | PREZZO<br>Price € | CONF.<br>Unit/Box |
|----------------|---------------------|-------------------|-------------------|
| 650 0096       | 4 - 15 l/min * (L)  | 1.000,55          | 1/1               |
| 650 0091       | 8 - 30 l/min * (L)  | 1.004,10          | 1/1               |
| 650 0092       | 10 - 40 l/min * (L) | 1.004,10          | 1/1               |
| 650 0051       | 4 - 15 l/min * (R)  | 1.011,07          | 1/1               |
| 650 0052       | 8 - 30 l/min * (R)  | 1.011,07          | 1/1               |
| 650 0053       | 10 - 40 l/min * (R) | 1.011,07          | 1/1               |

Forniti senza set valvole art. 651 0086 / Supplied without valve kit art. 651 0086



### ART. 6500G03

Modulo riscaldamento con valvola a 3 vie "BASIC-HT"  
Heating measuring consumption module with 3-ways valve "BASIC-HT"

| CODICE<br>Code | TIPO<br>Size        | PREZZO<br>Price € | CONF.<br>Unit/Box |
|----------------|---------------------|-------------------|-------------------|
| 650 0093       | 4 - 15 l/min * (L)  | 1.092,38          | 1/1               |
| 650 0094       | 8 - 30 l/min * (L)  | 1.095,94          | 1/1               |
| 650 0095       | 10 - 40 l/min * (L) | 1.095,94          | 1/1               |
| 650 0054       | 4 - 15 l/min * (R)  | 1.041,53          | 1/1               |
| 650 0055       | 8 - 30 l/min * (R)  | 1.041,53          | 1/1               |
| 650 0056       | 10 - 40 l/min * (R) | 1.041,53          | 1/1               |

Forniti senza set valvole art. 651 0086 / Supplied without valve kit art. 651 0086



### ART. 6500T

Tronchetti provvisori per moduli "BASIC-HT"  
Pipes for system washing/testing for "BASIC-HT" modules

| CODICE<br>Code | TIPO<br>Size | PREZZO<br>Price € | CONF.<br>Unit/Box |
|----------------|--------------|-------------------|-------------------|
| 651 0089       | "BASIC-HT"   | 3,96              | 1/10              |



### ART. 6500V01

Set valvole per moduli "BASIC-HT"  
Valves kit for "BASIC-HT" modules

| CODICE<br>Code | TIPO<br>Size  | PREZZO<br>Price € | CONF.<br>Unit/Box |
|----------------|---------------|-------------------|-------------------|
| 651 0086       | 1" F x 3/4" M | 67,56             | 1/10              |



### ART. 6500D

Set dime di fissaggio per moduli "BASIC-HT"  
Fixing brackets kit for "BASIC-HT" modules

| CODICE<br>Code | TIPO<br>Size | PREZZO<br>Price € | CONF.<br>Unit/Box |
|----------------|--------------|-------------------|-------------------|
| 651 0075       | "BASIC-HT"   | 27,89             | 1/25              |



### ART. 6500I

Isolamento termico per moduli "BASIC-HT"  
Thermal insulation for "BASIC-HT" modules

| CODICE<br>Code | TIPO<br>Size | PREZZO<br>Price € | CONF.<br>Unit/Box |
|----------------|--------------|-------------------|-------------------|
| 650 0057       | "BASIC-HT"   | 66,26             | 1/1               |

\* campo regolazione flussimetro  
balancing valve regulation

\*\* 1/10 : impulsi/litro (versione con lettura remota)  
1/10 : pulse/liter (remote reading version)

(L) strumentazione con lettura locale / direct reading meters

(R) strumentazione con predisposizione per lettura remota / remote reading meters



**ART. 6530G**  
 Stacco miscelazione per distribuzione sanitaria  
*Mixing unit for hot domestic water*

| CODICE<br>Code | TIPO<br>Size | PREZZO<br>Price € | CONF.<br>Unit/Box |
|----------------|--------------|-------------------|-------------------|
| 651 0001       | 3/4"         | 140,33            | 1/1               |



**ART. 6531G**  
 Valvola di bilanciamento con flussometro  
*Balancing valve with flow meter*

| CODICE<br>Code | TIPO<br>Size    | PREZZO<br>Price € | CONF.<br>Unit/Box |
|----------------|-----------------|-------------------|-------------------|
| 651 0002       | 1" - 4÷15l/min  | 75,29             | 1/25              |
| 651 0003       | 1" - 8÷30l/min  | 75,26             | 1/25              |
| 651 0004       | 1" - 10÷40l/min | 75,26             | 1/25              |



**ART. 6532G**  
 Kit collegamento per collettori di distribuzione (posizionamento a sinistra)  
*Connection kit for distribution manifolds (placed on the left)*

| CODICE<br>Code | TIPO<br>Size | PREZZO<br>Price € | CONF.<br>Unit/Box |
|----------------|--------------|-------------------|-------------------|
| 651 0005       | 3/4" - 1"    | 81,55             | 1/10              |



**ART. 6533G**  
 Kit collegamento per collettori di distribuzione (posizionamento a destra)  
*Connection kit for distribution manifolds (placed on the right)*

| CODICE<br>Code | TIPO<br>Size | PREZZO<br>Price € | CONF.<br>Unit/Box |
|----------------|--------------|-------------------|-------------------|
| 651 0006       | 3/4" - 1"    | 82,18             | 1/10              |



**ART. 6534G**  
 Valvola di by-pass differenziale  
*Differential by-pass valve*

| CODICE<br>Code | TIPO<br>Size | PREZZO<br>Price € | CONF.<br>Unit/Box |
|----------------|--------------|-------------------|-------------------|
| 651 0007       | 0÷400 mbar   | 42,95             | 2/10              |



**ART. 6535G**  
 Valvola di bilanciamento  
*Balancing valve*

| CODICE<br>Code | TIPO<br>Size | PREZZO<br>Price € | CONF.<br>Unit/Box |
|----------------|--------------|-------------------|-------------------|
| 651 0008       | 1/2"         | 63,17             | 1/5               |
| 651 0009       | 3/4"         | 65,13             | 1/5               |
| 651 0010       | 1"           | 75,22             | 1/5               |
| 651 0011       | 1"1/4        | 93,12             | 1/5               |
| 651 0012       | 1"1/2        | 117,44            | 1/4               |
| 651 0013       | 2"           | 158,57            | 1/4               |



**ART. 1868SH**  
 Collettore con rubinetti di arresto Maxima in ottone CW617N giallo. Derivazione con interasse 36 mm e attacchi 1/2"x15  
*Manifold with stop cocks made of CW617N. Outlets with distance between centres 36 mm and 1/2"x15 connections*

| CODICE<br>Code | TIPO<br>Size       | PREZZO<br>Price € | CONF.<br>Unit/Box |
|----------------|--------------------|-------------------|-------------------|
| 186 0040       | 1" G - 2 - 1/2"x15 | vedi cap. 17      | 4/32              |
| 186 0042       | 1" G - 3 - 1/2"x15 | vedi cap. 17      | 4/16              |
| 186 0039       | 1" G - 4 - 1/2"x15 | vedi cap. 17      | 4/16              |
| 186 0033       | 1" G - 5 - 1/2"x15 | vedi cap. 17      | 4/16              |



**ART. 1522**  
 Kit raccordi per connessione contatori  
*Kit of tails and loose nuts for counters*

| CODICE<br>Code | TIPO<br>Size    | PREZZO<br>Price € | CONF.<br>Unit/Box |
|----------------|-----------------|-------------------|-------------------|
| 150 0035       | 1/2"M x 3/4"F   | vedi cap. 10      | 1/80              |
| 150 0042       | 3/4"M x 1"F     | vedi cap. 10      | 1/40              |
| 150 0062       | 1"M x 1"1/4F    | vedi cap. 10      | 1/20              |
| 150 0094       | 1"1/4M x 1"1/2F | vedi cap. 10      | 1/15              |
| 150 0072       | 1"1/2M x 2"F    | vedi cap. 10      | 1/10              |
| 150 0101       | 2"M x 2"1/2F    | vedi cap. 10      | 1/5               |



### ART. 1937

Cassetta metallica completa di kit di chiusura per moduli "VARIO"  
Metallic box with closure kit for "VARIO" modules

| CODICE<br>Code | TIPO<br>Size    | PREZZO<br>Price € | CONF.<br>Unit/Box |
|----------------|-----------------|-------------------|-------------------|
| 181 0099       | 640x640x120÷170 | 203,87            | 1/1               |



### ART. 1940B

Cassetta metallica completa di kit di chiusura per moduli "FLOOR" e "HEAT"  
Metallic box with closure kit for "FLOOR" and "HEAT" modules

| CODICE<br>Code | TIPO<br>Size (mm) | PREZZO<br>Price € | CONF.<br>Unit/Box |
|----------------|-------------------|-------------------|-------------------|
| 181 0020       | 600x670x120÷170   | vedi cap. 17      | 1/1               |
| 181 0016       | 700x670x120÷170   | vedi cap. 17      | 1/1               |
| 181 0015       | 850x670x120÷170   | vedi cap. 17      | 1/1               |
| 181 0019       | 1000x670x120÷170  | vedi cap. 17      | 1/1               |
| 181 0025       | 1200x670x120÷170  | vedi cap. 17      | 1/1               |



### ART. 2133

Valvola a sfera motorizzata a 2 vie - attacchi a 2 bocchettoni  
2-ways motorized ball valve - 2 unions connection

| CODICE<br>Code | TIPO<br>Size | PREZZO<br>Price € | CONF.<br>Unit/Box |
|----------------|--------------|-------------------|-------------------|
| 213 0011       | 3/4"         | vedi cap. 17      | 1/14              |
| 213 0016       | 1"           | vedi cap. 17      | 1/14              |



### ART. 2137

Valvola a sfera motorizzata a 3 vie con by-pass - attacchi a 3 bocchettoni  
3-ways motorized ball valve with by-pass - 3 unions connection

| CODICE<br>Code | TIPO<br>Size | PREZZO<br>Price € | CONF.<br>Unit/Box |
|----------------|--------------|-------------------|-------------------|
| 213 0021       | 3/4"         | vedi cap. 17      | 1/14              |
| 213 0015       | 1"           | vedi cap. 17      | 1/14              |



### ART. 2266

Valvola sfera per moduli di contabilizzazione  
Ball valve for measuring consumption modules

| CODICE<br>Code                         | TIPO<br>Size  | PREZZO<br>Price € | CONF.<br>Unit/Box |
|--|---------------|-------------------|-------------------|
| con farfalla blu / with blue T handle  |               |                   |                   |
| 226 0008                               | 3/4"M - 3/4"F | 10,93             | 20/80             |
| 226 0018                               | 3/4"M - 1"F   | 11,61             | 20/80             |
| con farfalla rossa / with red T handle |               |                   |                   |
| 226 0010                               | 3/4"M - 3/4"F | 10,93             | 20/80             |
| 226 0012                               | 3/4"M - 1"F   | 11,61             | 20/80             |



### ART. 2266CK

Valvola sfera con non-ritorno per moduli di contabilizzazione  
Ball valve with built-in check for measuring consumption modules

| CODICE<br>Code                         | TIPO<br>Size  | PREZZO<br>Price € | CONF.<br>Unit/Box |
|--|---------------|-------------------|-------------------|
| con farfalla blu / with blue T handle  |               |                   |                   |
| 226 0009                               | 3/4"M - 3/4"F | 13,52             | 20/80             |
| 226 0011                               | 3/4"M - 1"F   | 13,52             | 20/80             |
| con farfalla rossa / with red T handle |               |                   |                   |
| 226 0019                               | 3/4"M - 3/4"F | 15,56             | 20/80             |
| 226 0013                               | 3/4"M - 1"F   | 15,56             | 20/80             |



### ART. 2985

Valvola a sfera a passaggio totale con attacco M10x1 per sonda temperatura  
Full bore ball valve with M10x1 connection for thermal probe

| CODICE<br>Code | TIPO<br>Size | PREZZO<br>Price € | CONF.<br>Unit/Box |
|----------------|--------------|-------------------|-------------------|
| 298 0006       | 1/2"         | vedi cap. 1       | 25/100            |
| 298 0001       | 3/4"         | vedi cap. 1       | 15/60             |
| 298 0008       | 1"           | vedi cap. 1       | 10/40             |



### ART. 3670PS

Raccordo con attacco M10x1 per sonda temperatura  
Fitting with M10x1 connection for thermal probe

| CODICE<br>Code | TIPO<br>Size | PREZZO<br>Price € | CONF.<br>Unit/Box |
|----------------|--------------|-------------------|-------------------|
| 651 0015       | 3/4"         | 10,35             | 18/54             |
| 651 0016       | 1"           | 17,58             | 10/30             |
| 651 0017       | 1"1/4        | 24,85             | 4/16              |
| 651 0018       | 1"1/2        | 36,45             | 3/12              |
| 651 0019       | 2"           | 54,48             | 2/8               |



### ART. 6500P01

Dima per fissaggio componenti moduli di contabilizzazione "VARIO"  
*Plate to fix components for "VARIO" modules*

| 29,16 CODICE<br>Code | TIPO<br>Size | PREZZO<br>Price € | CONF.<br>Unit/Box |
|----------------------|--------------|-------------------|-------------------|
| 651 0014             | "VARIO"      | 29,16             | 1/1               |



### ART. 6500T

Tronchetti provvisori  
*Pipes for system washing/testing*

| CODICE<br>Code | TIPO<br>Size    | PREZZO<br>Price € | CONF.<br>Unit/Box |
|----------------|-----------------|-------------------|-------------------|
| 651 0080       | "VARIO"         | 6,25              | 1/10              |
| 651 0081       | "FLOOR"         | 53,25             | 1/10              |
| 651 0082       | "HEAT"          | 103,56            | 1/10              |
| 651 0083       | "BASIC-1,5M3/H" | 2,23              | 1/25              |
| 651 0084       | "BASIC-2,5M3/H" | 22,68             | 1/25              |
| 651 0089       | "BASIC-HT"      | 3,96              | 1/10              |



### ART. 6500D

Dime di fissaggio per moduli di contabilizzazione  
*Fixing brackets for metering consumption modules*

| CODICE<br>Code | TIPO<br>Size | PREZZO<br>Price € | CONF.<br>Unit/Box |
|----------------|--------------|-------------------|-------------------|
| 651 0075       | "BASIC-HT"   | 27,89             | 1/25              |
| 651 0076       | "FLOOR"      | 41,74             | 1/10              |
| 651 0077       | "HEAT"       | 41,74             | 1/10              |



### ART. 6510D

Dime di fissaggio per moduli di contabilizzazione  
*Fixing brackets for metering consumption modules*

| CODICE<br>Code | TIPO<br>Size    | PREZZO<br>Price € | CONF.<br>Unit/Box |
|----------------|-----------------|-------------------|-------------------|
| 651 0078       | 6510/13-1,5m3/h | 54,99             | 1/20              |
| 651 0079       | 6511/12-1,5m3/h | 52,38             | 1/20              |
| 651 0099       | 6510/13-2,5m3/h | 38,68             | 1/12              |
| 651 0100       | 6511/12-2,5m3/h | 39,46             | 1/12              |



### ART. 6500I

Isolamento termico per moduli "VARIO" e "BASIC-HIT"  
*Thermal insulation for "VARIO" and "BASIC-HIT" modules*

| CODICE<br>Code | TIPO<br>Size        | PREZZO<br>Price € | CONF.<br>Unit/Box |
|----------------|---------------------|-------------------|-------------------|
| 650 0057       | "VARIO"- "BASIC-HT" | 66,26             | 1/1               |



### ART. 6500II

Isolamento termico per moduli "FLOOR"  
*Thermal insulation for "FLOOR" modules*

| CODICE<br>Code | TIPO<br>Size | PREZZO<br>Price € | CONF.<br>Unit/Box |
|----------------|--------------|-------------------|-------------------|
| 650 0058       | "FLOOR"      | 80,62             | 1/1               |



# CONTATORI, CONTABILIZZATORI ED ACCESSORI

## VOLUMETRIC METERS, ENERGY METERS AND ACCESSORIES



### ART. 6560C

Misuratore compatto di calorie/frigorie  
Energy meter

| CODICE<br>Code | TIPO<br>Size                        | PREZZO<br>Price € | CONF.<br>Unit/Box |
|----------------|-------------------------------------|-------------------|-------------------|
| 651 0020       | DN15 1/2" - 1,5m <sup>3</sup> /h    | 600,84            | 1/6               |
| 651 0021       | DN15 - 1,5m <sup>3</sup> /h - 1/10* | 719,52            | 1/6               |
| 651 0022       | DN20 - 2,5m <sup>3</sup> /h         | 625,26            | 1/6               |
| 651 0023       | DN20 - 2,5m <sup>3</sup> /h - 1/10* | 743,92            | 1/6               |

\* 1/10: impulsi/litro (versione con lettura remota, interfaccia M-Bus e 2 ingressi impulsivi)

\* 1/10: pulse/liter (remote reading version, M-Bus interface and 2 pulse input)



### ART. 6561E

Cavo emettitore lancia impulsi  
Pulse launcher cable

| CODICE<br>Code | TIPO<br>Size      | PREZZO<br>Price € | CONF.<br>Unit/Box |
|----------------|-------------------|-------------------|-------------------|
| 651 0085       | per/for 6561C     | 27,99             | 1/10              |
| 651 0126       | per/for 6561D-30° | 27,99             | 1/10              |
| 651 0127       | per/for 6561D-90° | 27,99             | 1/10              |



### ART. 6562C

Contatore volumetrico a getto  
multiplo per acqua calda (fino a  
120°C) con uscita impulsiva  
Multi-jet hot (up to 120°C) water  
volumetric counter with pulse  
launch

| CODICE<br>Code | TIPO<br>Size                         | PREZZO<br>Price € | CONF.<br>Unit/Box |
|----------------|--------------------------------------|-------------------|-------------------|
| 651 0032       | DN15 - 1,5m <sup>3</sup> /h - 1/10*  | 474,38            | 1/4               |
| 651 0033       | DN20 - 2,5m <sup>3</sup> /h - 1/10*  | 447,98            | 1/4               |
| 651 0034       | DN25 - 3,5m <sup>3</sup> /h - 1/10*  | 490,49            | 1/2               |
| 651 0036       | DN32 - 6,0m <sup>3</sup> /h - 1/10*  | 533,98            | 1/2               |
| 651 0037       | DN40 - 10,0m <sup>3</sup> /h - 1/10* | 835,44            | 1/1               |
| 651 0035       | DN50 - 20,0m <sup>3</sup> /h - 1/10* | 490,49            | 1/1               |

\* impulsi/litro (necessario per la scelta del calorimetro Art. 6564C)  
pulse/liter (to be used to chose the relevant Art. 6564C)



### ART. 6561C

Contatore volumetrico per acqua  
calda o fredda con lettura locale o  
a distanza  
Hot/cold water volumetric counter  
with direct or remote reading

| CODICE<br>Code | TIPO<br>Size (mm)                     | PREZZO<br>Price € | CONF.<br>Unit/Box |
|----------------|---------------------------------------|-------------------|-------------------|
| 651 0024       | DN15-1,5m <sup>3</sup> /h - 30°       | 98,06             | 1/12              |
| 651 0025       | DN15-1,5m <sup>3</sup> /h - 30°-1/10* | 132,95            | 1/12              |
| 651 0026       | DN15-1,5m <sup>3</sup> /h - 90°       | 94,56             | 1/12              |
| 651 0027       | DN15-1,5m <sup>3</sup> /h - 90°-1/10* | 129,46            | 1/12              |
| 651 0028       | DN20-2,5m <sup>3</sup> /h - 30°       | 130,16            | 1/12              |
| 651 0029       | DN20-2,5m <sup>3</sup> /h - 30°-1/10* | 165,06            | 1/12              |
| 651 0030       | DN20-2,5m <sup>3</sup> /h - 90°       | 126,67            | 1/12              |
| 651 0031       | DN20-2,5m <sup>3</sup> /h - 90°-1/10* | 161,57            | 1/12              |



### ART. 6561D

Contatore volumetrico a getto  
singolo per acqua calda o fredda  
con lettura locale oppure a  
distanza  
Single-jet hot/cold water volumetric  
counter with direct or remote  
reading

| CODICE<br>Code | TIPO<br>Size (mm)                  | PREZZO<br>Price € | CONF.<br>Unit/Box |
|----------------|------------------------------------|-------------------|-------------------|
| 651 0101       | DN25 - 3,5m <sup>3</sup> /h - 30°  | 430,38            | 1/2               |
| 651 0102       | DN32 - 6,0m <sup>3</sup> /h - 30°  | 539,68            | 1/2               |
| 651 0103       | DN40 - 10,0m <sup>3</sup> /h - 30° | 966,71            | 1/1               |
| 651 0104       | DN50 - 20,0m <sup>3</sup> /h - 30° | 1.223,44          | 1/1               |
| 651 0105       | DN25 - 3,5m <sup>3</sup> /h - 90°  | 443,09            | 1/2               |
| 651 0106       | DN32 - 6,0m <sup>3</sup> /h - 90°  | 443,09            | 1/2               |
| 651 0107       | DN40 - 10,0m <sup>3</sup> /h - 90° | 755,74            | 1/1               |
| 651 0108       | DN50 - 20,0m <sup>3</sup> /h - 90° | 1.048,05          | 1/1               |



### ART. 6563C

Contatore volumetrico a getto  
singolo per acqua calda o fredda  
con lettura locale oppure a  
distanza  
Single-jet hot/cold water volumetric  
counter with direct or remote  
reading

| CODICE<br>Code | TIPO<br>Size (mm)              | PREZZO<br>Price € | CONF.<br>Unit/Box |
|----------------|--------------------------------|-------------------|-------------------|
| 651 0038       | DN50 - 15,0m <sup>3</sup> /h   | 1.616,82          | 1/2               |
| 651 0039       | DN65 - 25,0m <sup>3</sup> /h   | 1.803,19          | 1/2               |
| 651 0040       | DN80 - 40,0m <sup>3</sup> /h   | 1.927,42          | 1/2               |
| 651 0041       | DN100 - 60,0m <sup>3</sup> /h  | 2.053,68          | 1/1               |
| 651 0042       | DN125 - 100,0m <sup>3</sup> /h | 2.409,78          | 1/1               |
| 651 0043       | DN150 - 150,0m <sup>3</sup> /h | 2.507,51          | 1/1               |
| 651 0044       | DN200 - 250,0m <sup>3</sup> /h | 3.727,25          | 1/1               |
| 651 0045       | DN250 - 400,0m <sup>3</sup> /h | 16.263,74         | 1/1               |

## CONTATORI, CONTABILIZZATORI ED ACCESSORI

### VOLUMETRIC METERS, ENERGY METERS AND ACCESSORIES



**ART. 6564C**  
 Unità elettronica di calcolo  
 calorie/frigorie  
*Electronic measuring unit for  
 thermal energy*

| CODICE<br>Code | TIPO<br>Size | PREZZO<br>Price € | CONF.<br>Unit/Box |
|----------------|--------------|-------------------|-------------------|
| 651 0046       | 1/10 Imp/L   | 577,11            | 1/4               |
| 651 0047       | 1/100 Imp/L  | 577,11            | 1/4               |
| 651 0048       | 1/1000 Imp/L | 577,11            | 1/4               |



**ART. 6565S**  
 Coppia sonde di temperatura  
 Pt500 con cavo di lunghezza 3mt  
*Couple of thermal probes Pt500 with  
 3mt wire*

| CODICE<br>Code | TIPO<br>Size (mm)   | PREZZO<br>Price € | CONF.<br>Unit/Box |
|----------------|---------------------|-------------------|-------------------|
| 651 0049       | Ø5mm - bagnato/wet  | 79,32             | 1/10              |
| 651 0050       | Ø6mm - asciutto/dry | 98,93             | 1/10              |



**ART. 6566C**  
 Kit configurazione per unità elet-  
 troniche  
*Configuration kit for electronic units*

| CODICE<br>Code | TIPO<br>Size           | PREZZO<br>Price € | CONF.<br>Unit/Box |
|----------------|------------------------|-------------------|-------------------|
| 651 0051       | versione / version USB | 677,51            | 1/50              |



**ART. 6567C**  
 Coppia pozzetti porta sonda  
 (montaggio "asciutto")  
*Couple of thermal probes pot (dry  
 installation)*

| CODICE<br>Code | TIPO<br>Size (mm) | PREZZO<br>Price € | CONF.<br>Unit/Box |
|----------------|-------------------|-------------------|-------------------|
| 651 0052       | DN32 - DN65       | 162,58            | 1/100             |
| 651 0053       | DN80 - DN125      | 190,36            | 1/50              |
| 651 0054       | DN150 - DN200     | 218,99            | 1/10              |



**ART. 3670PS**  
 Raccordo con attacco M10x1 per  
 sonda temperatura  
*Fitting with M10x1 connection for  
 thermal probe*

| CODICE<br>Code | TIPO<br>Size | PREZZO<br>Price € | CONF.<br>Unit/Box |
|----------------|--------------|-------------------|-------------------|
| 651 0015       | 3/4"         | 10,35             | 18/54             |
| 651 0016       | 1"           | 17,58             | 10/30             |
| 651 0017       | 1"1/4        | 24,85             | 4/16              |
| 651 0018       | 1"1/2        | 36,45             | 3/12              |
| 651 0019       | 2"           | 54,48             | 2/8               |

#### MONTAGGIO "BAGNATO" WET INSTALLATION

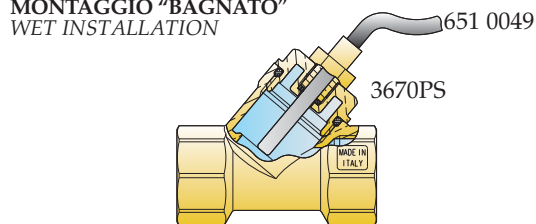

#### MONTAGGIO "ASCIUTTO" DRY INSTALLATION

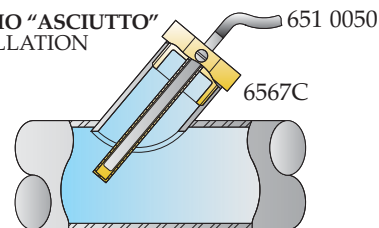

**ART. 6568C**  
 Misuratore ad ultrasuoni di calorie  
 e frigorie con attacchi filettati  
 maschio/maschio  
*Ultrasonic meter for thermal energy  
 with threaded male ends*

| CODICE<br>Code | TIPO<br>Size (mm)            | PREZZO<br>Price € | CONF.<br>Unit/Box |
|----------------|------------------------------|-------------------|-------------------|
| 651 0055       | DN15 - 1,5m <sup>3</sup> /h  | 1.325,60          | 1/1               |
| 651 0056       | DN20 - 2,5m <sup>3</sup> /h  | 1.387,50          | 1/1               |
| 651 0057       | DN25 - 3,5m <sup>3</sup> /h  | 2.758,62          | 1/1               |
| 651 0058       | DN32 - 6,0m <sup>3</sup> /h  | 2.758,62          | 1/1               |
| 651 0059       | DN40 - 10,0m <sup>3</sup> /h | 3.609,63          | 1/1               |



**ART. 6569C**  
 Calorimetro ad ultrasuoni di cal-  
 orie e frigorie con attacchi flangiati  
*Ultrasonic meter for thermal energy  
 with flanged ends*

| CODICE<br>Code | TIPO<br>Size (mm)              | PREZZO<br>Price € | CONF.<br>Unit/Box |
|----------------|--------------------------------|-------------------|-------------------|
| 651 0060       | DN50 - 15,0 m <sup>3</sup> /h  | 5.566,33          | 1/1               |
| 651 0061       | DN65 - 25,0 m <sup>3</sup> /h  | 7.637,81          | 1/1               |
| 651 0062       | DN80 - 40,0 m <sup>3</sup> /h  | 8.299,53          | 1/1               |
| 651 0063       | DN100 - 60,0 m <sup>3</sup> /h | 12.458,42         | 1/1               |

# CONTATORI, CONTABILIZZATORI ED ACCESSORI

## VOLUMETRIC METERS, ENERGY METERS AND ACCESSORIES

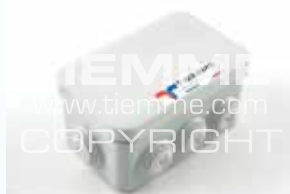

**ART. 6570C**  
Cassetta collegamenti elettrici  
Electrical connection box

| CODICE<br>Code | TIPO<br>Size      | PREZZO<br>Price € | CONF.<br>Unit/Box |
|----------------|-------------------|-------------------|-------------------|
| 651 0064       | "VARIO" - "FLOOR" | 63,89             | 1/1               |
| 651 0065       | "HEAT"            | 136,45            | 1/1               |



**ART. 6571C**  
Concentratore M-bus con  
memoria interna  
M-Bus datalogger with internal  
memory

| CODICE<br>Code | TIPO<br>Size (mm)          | PREZZO<br>Price € | CONF.<br>Unit/Box |
|----------------|----------------------------|-------------------|-------------------|
| 651 0066       | per /for 20 unità /slaves  | 2.338,48          | 1/8               |
| 651 0067       | per /for 60 unità /slaves  | 2.537,82          | 1/2               |
| 651 0068       | per /for 240 unità /slaves | 4.618,60          | 1/1               |



**ART. 6573C**  
Modem analogico per concentrato-  
re M-Bus  
Analogic modem for M-Bus  
datalogger

| CODICE<br>Code | TIPO<br>Size           | PREZZO<br>Price € | CONF.<br>Unit/Box |
|----------------|------------------------|-------------------|-------------------|
| 651 0071       | per /for 651 0067      | 706,03            | 1/4               |
| 651 0072       | per /for 651 0066-0068 | 706,03            | 1/4               |



**ART. 6574C**  
Ripetitore per reti M-Bus  
M-Bus repeater

| CODICE<br>Code | TIPO<br>Size (mm) | PREZZO<br>Price € | CONF.<br>Unit/Box |
|----------------|-------------------|-------------------|-------------------|
| 651 0073       | per /for 6571C    | 5.341,20          | 1/100             |



**ART. 6575C**  
Adattatore di impulsi su M-Bus  
per contatori volumetrici (max 2)  
M-Bus pulse adaptor for volumetric  
counters (max 2)

| CODICE<br>Code | TIPO<br>Size   | PREZZO<br>Price € | CONF.<br>Unit/Box |
|----------------|----------------|-------------------|-------------------|
| 651 0074       | per /for 6561C | 281,67            | 1/10              |



**ART. 6576C**  
Concentratore M-Bus con display  
LCD "touch-screen"  
M-Bus datalogger with LCD touch-  
screen display

| CODICE<br>Code | TIPO<br>Size            | PREZZO<br>Price € | CONF.<br>Unit/Box |
|----------------|-------------------------|-------------------|-------------------|
| 651 0122       | 60 unità /slaves        | 6.519,32          | 1/1               |
| 651 0095       | 120 unità /slaves       | 7.249,09          | 1/1               |
| 651 0096       | 250 unità /slaves       | 8.291,62          | 1/1               |
| 651 0123       | 60 unità /slaves - GSM  | 8.395,88          | 1/1               |
| 651 0097       | 120 unità /slaves - GSM | 9.125,65          | 1/1               |
| 651 0098       | 250 unità /slaves - GSM | 10.168,18         | 1/1               |

