

2

36

1/2"
Ø16

Art. 1668K

Art. 1240K

Art. 1233K
Art. 1235K

Art. 144 0063

Art. 171

Art. 1435K

Art. 1635K

**GUIDA ALLE
CONNESSIONI**

**CONNECTION
GUIDE**

Art. 1240

Art. 1233
Art. 1235

MADE IN ITALY

ART. 1130CZ

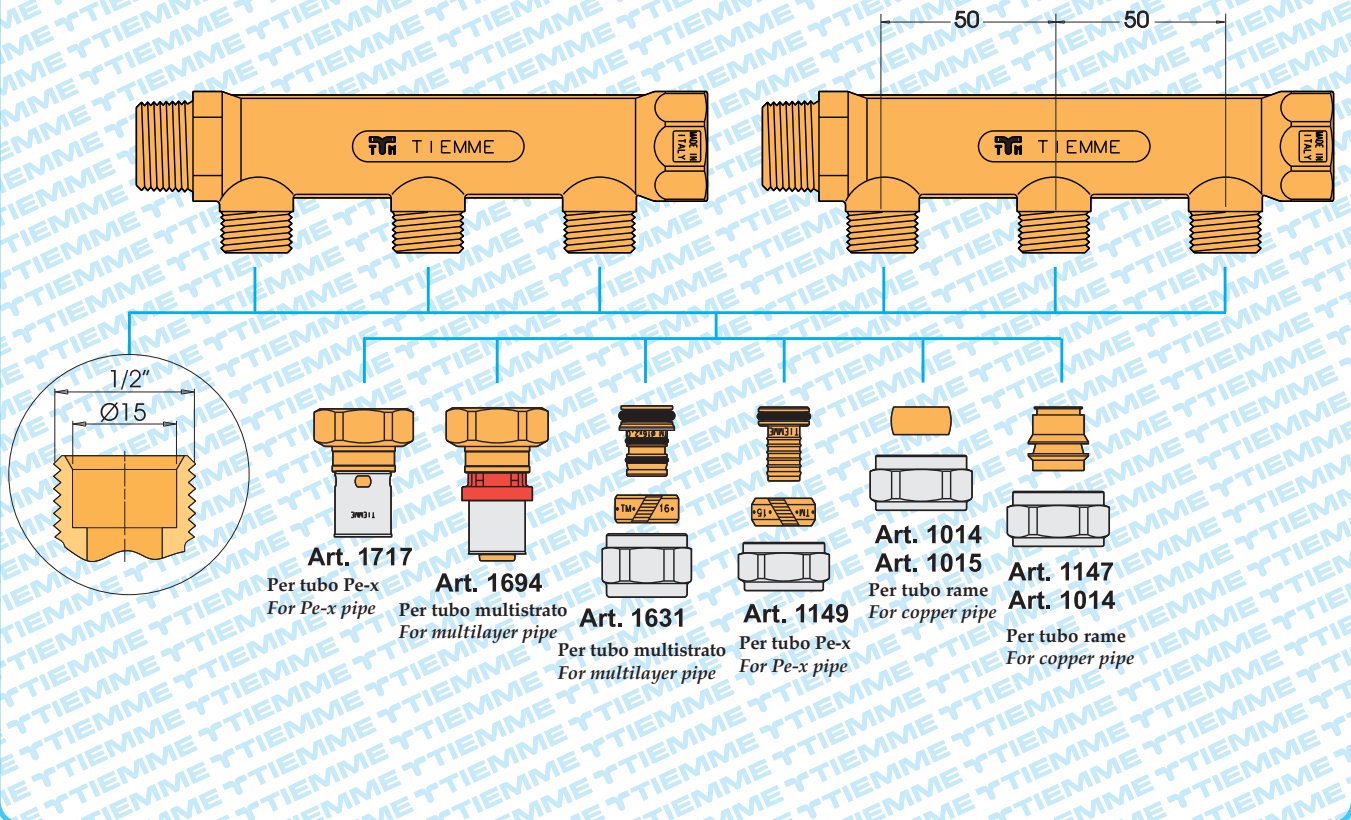

ART. 1420K - 1420KPEX

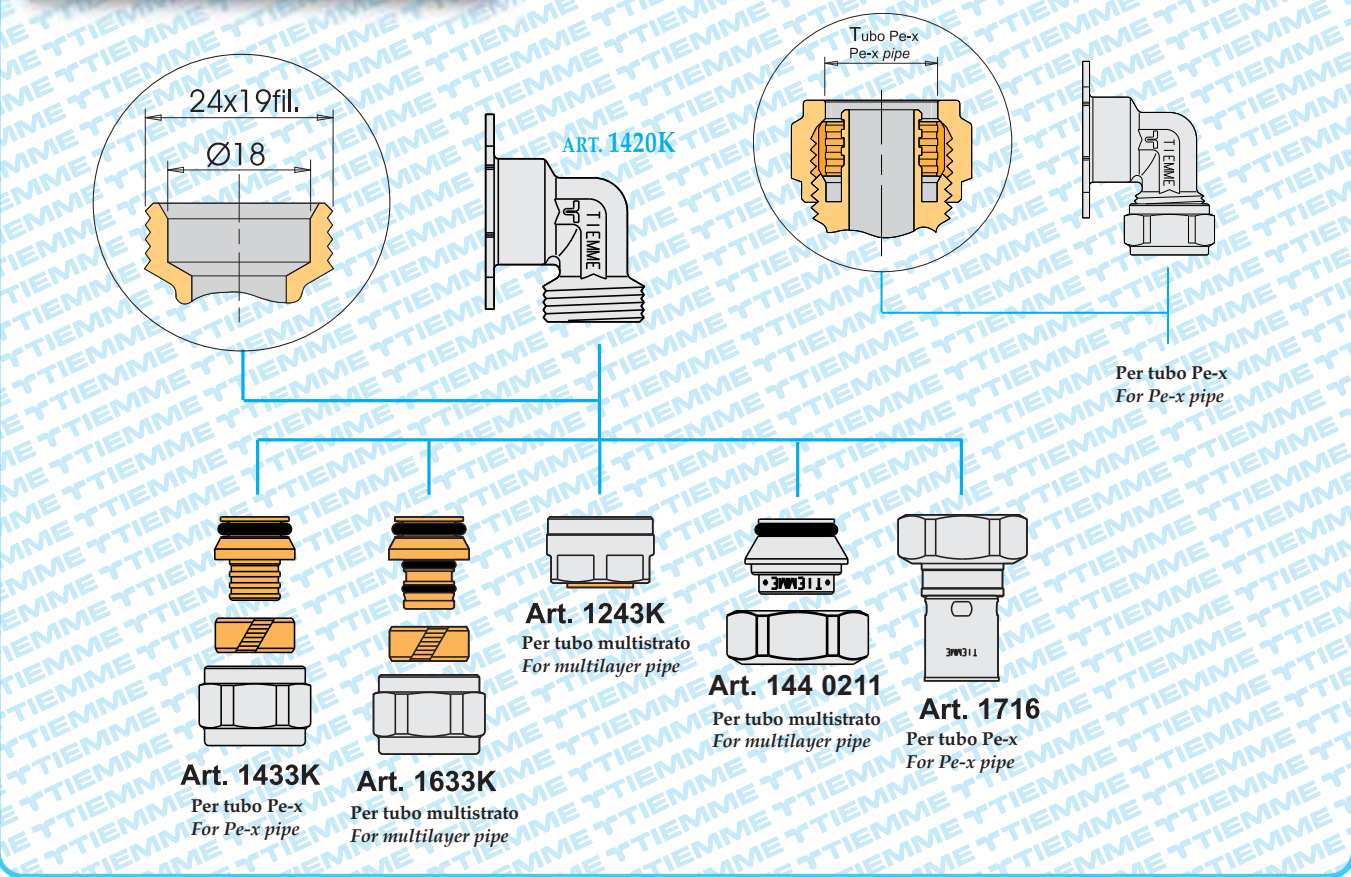

ART. 140 0150

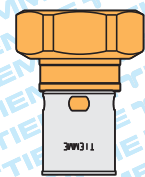
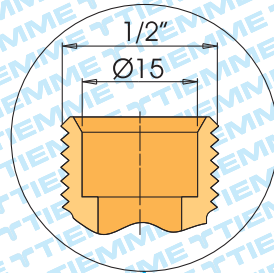
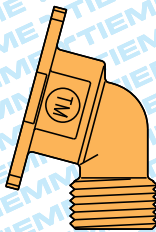

Art. 1717
Per tubo Pe-x
For Pe-x pipe

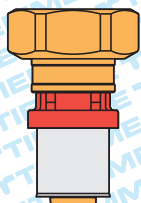

Art. 1694
Per tubo multistrato
For multilayer pipe



Art. 1631
Per tubo multistrato
For multilayer pipe



Art. 1149
Per tubo Pe-x
For Pe-x pipe

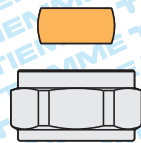

Art. 1014
Per tubo rame
For copper pipe

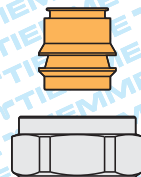

Art. 1147
Art. 1014
Per tubo rame
For copper pipe

ART. 140 0126

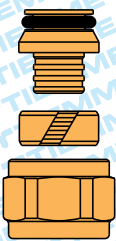
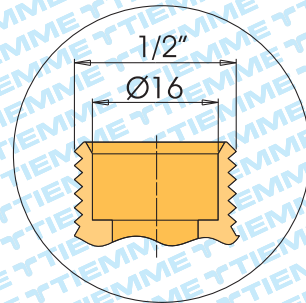
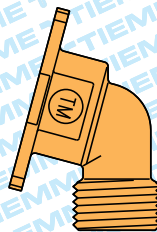

Art. 1435
Per tubo Pe-x
For Pe-x pipe

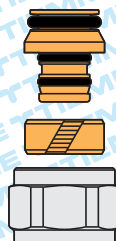

Art. 1635
Per tubo multistrato
For multilayer pipe



Art. 1240
Per tubo rame
For copper pipe

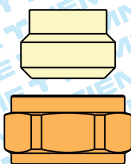

Art. 1233
Art. 1235
Per tubo rame
For copper pipe

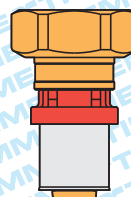

Art. 1668
Per tubo multistrato
For multilayer pipe

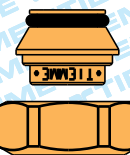

Art. 144 0063
Tappo
Cap

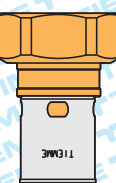

Art. 1716
Per tubo Pe-x
For Pe-x pipe

ART. 1802-1804

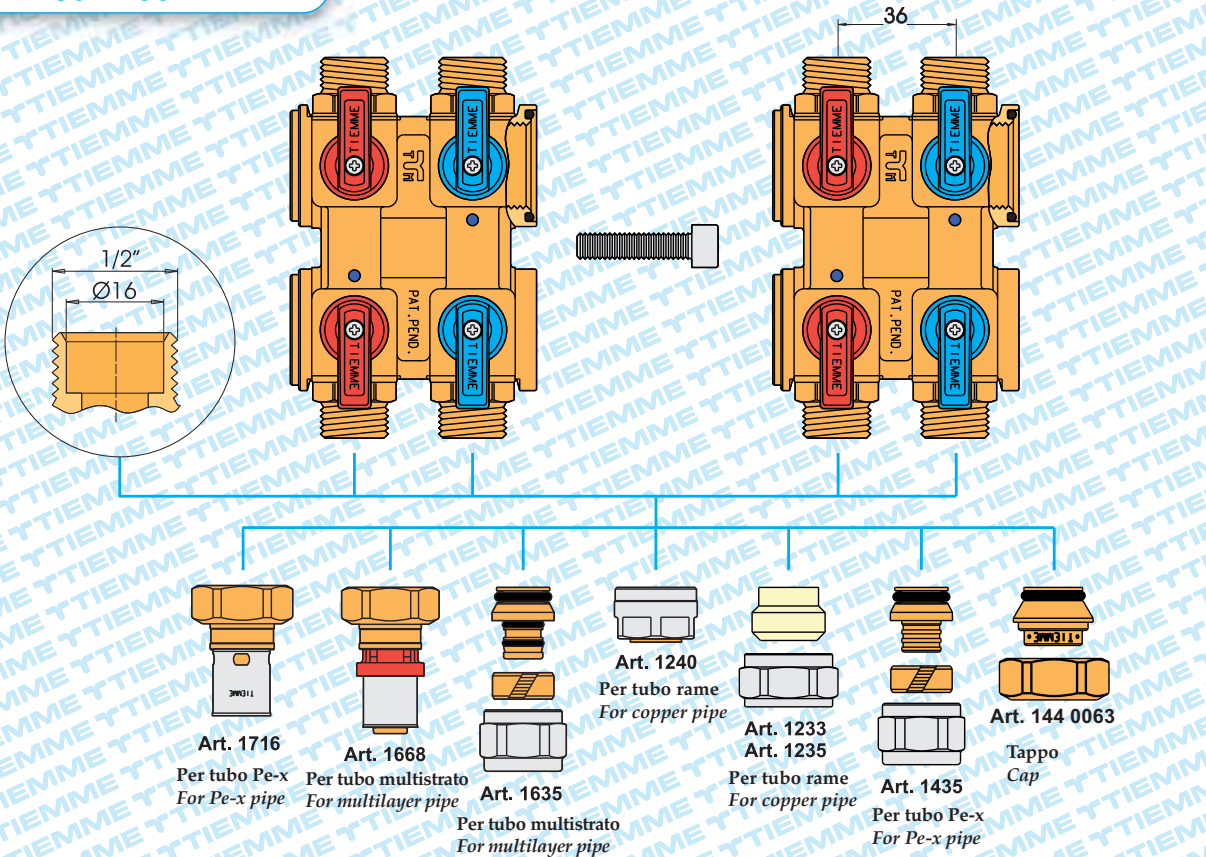

ART. 1802G16SH

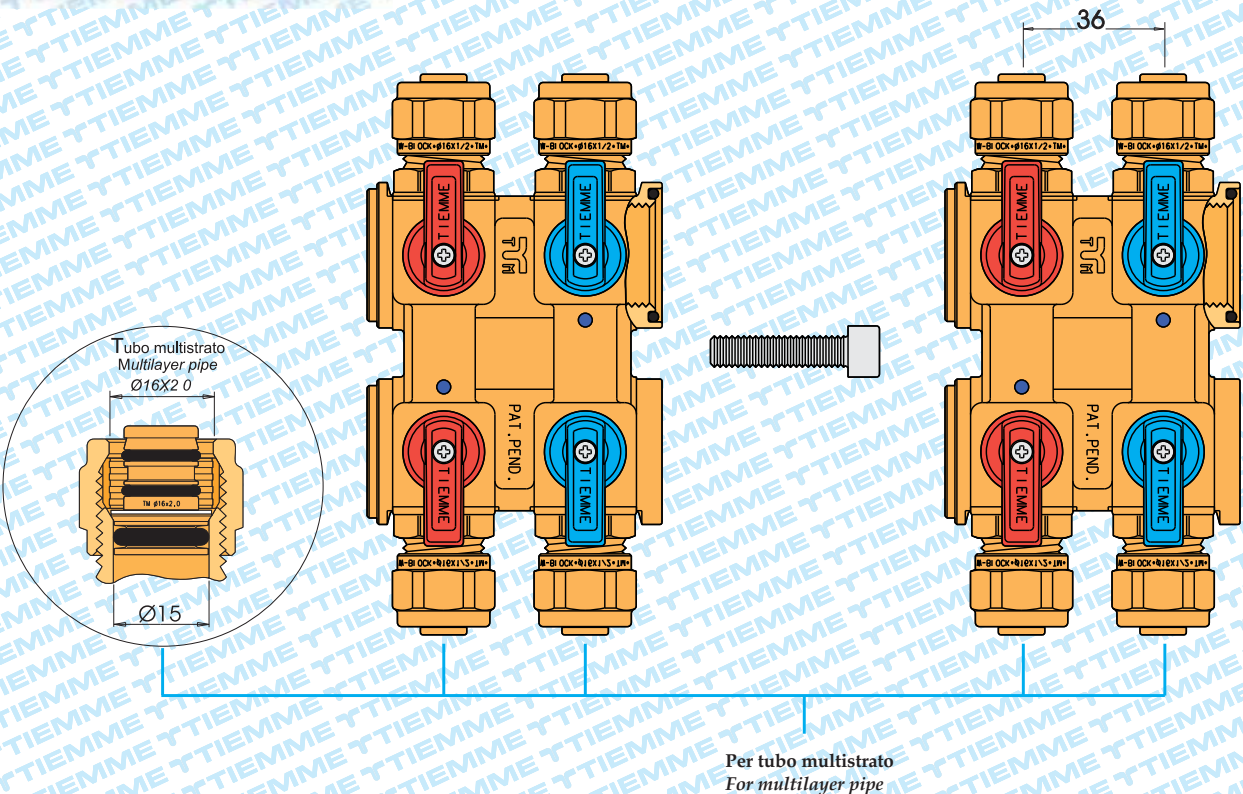

ART. 1822-1823-1832-1833

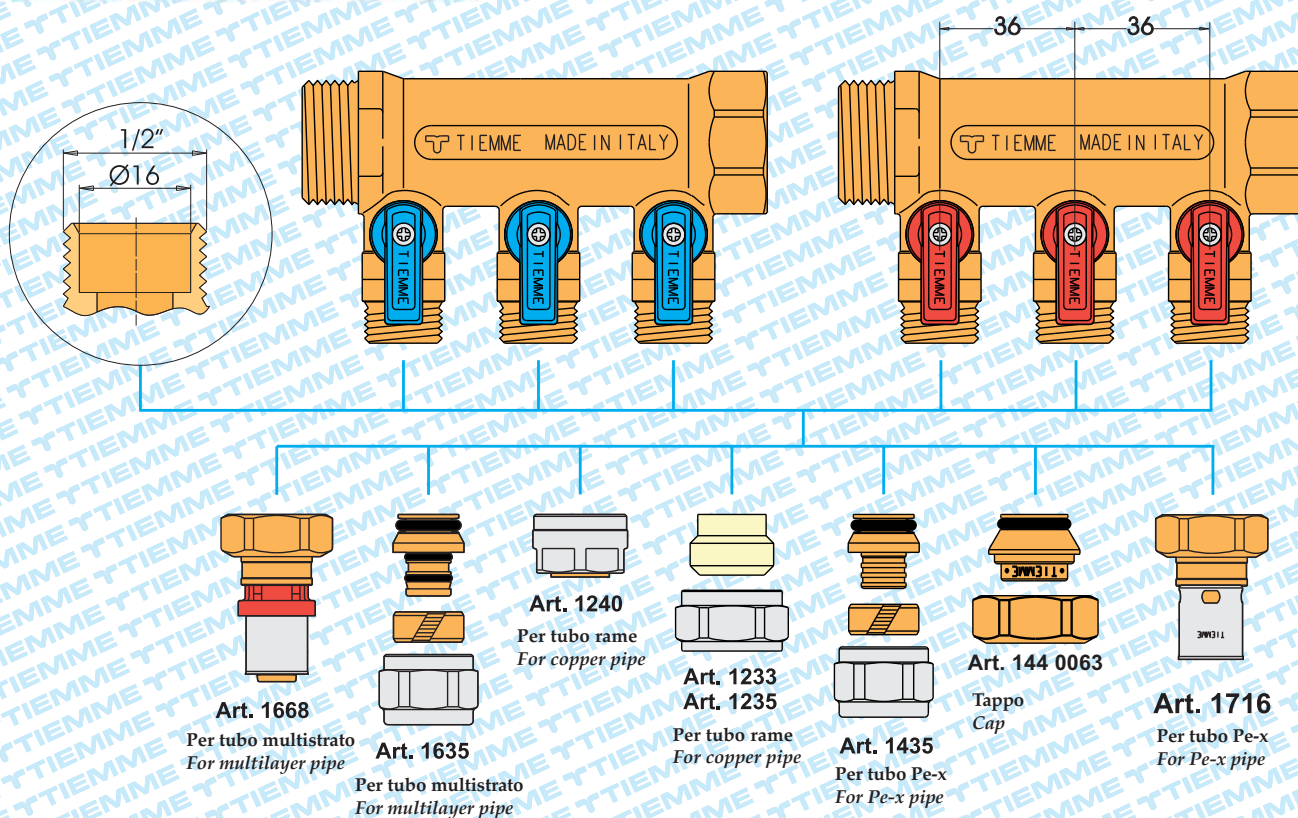

ART. 1822CP-1823CP-1823CP-1833CP

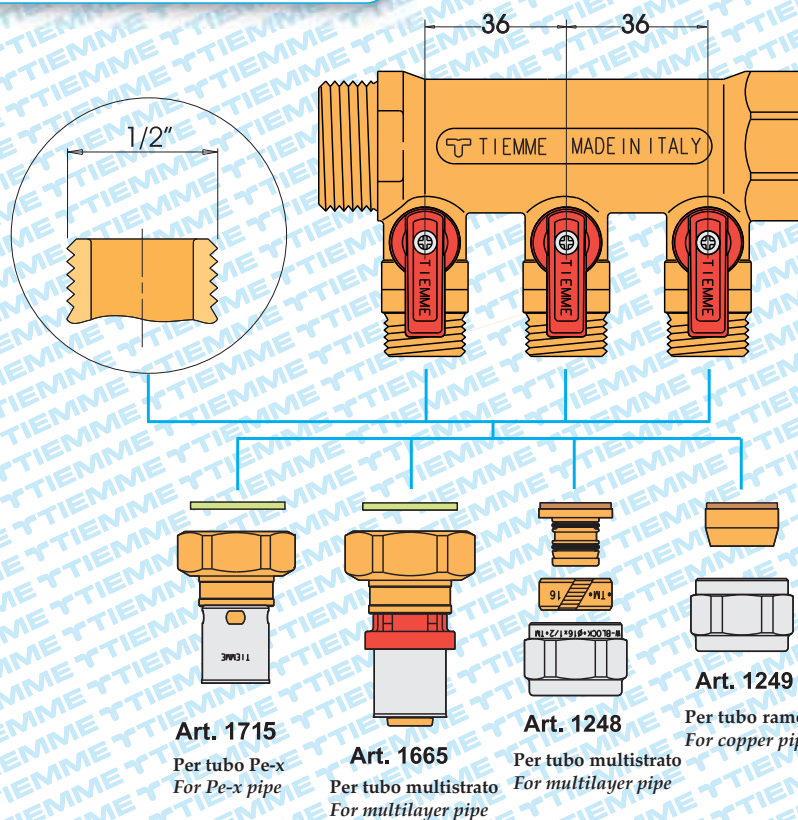

ART. 1822SH-1823SH-1824SH

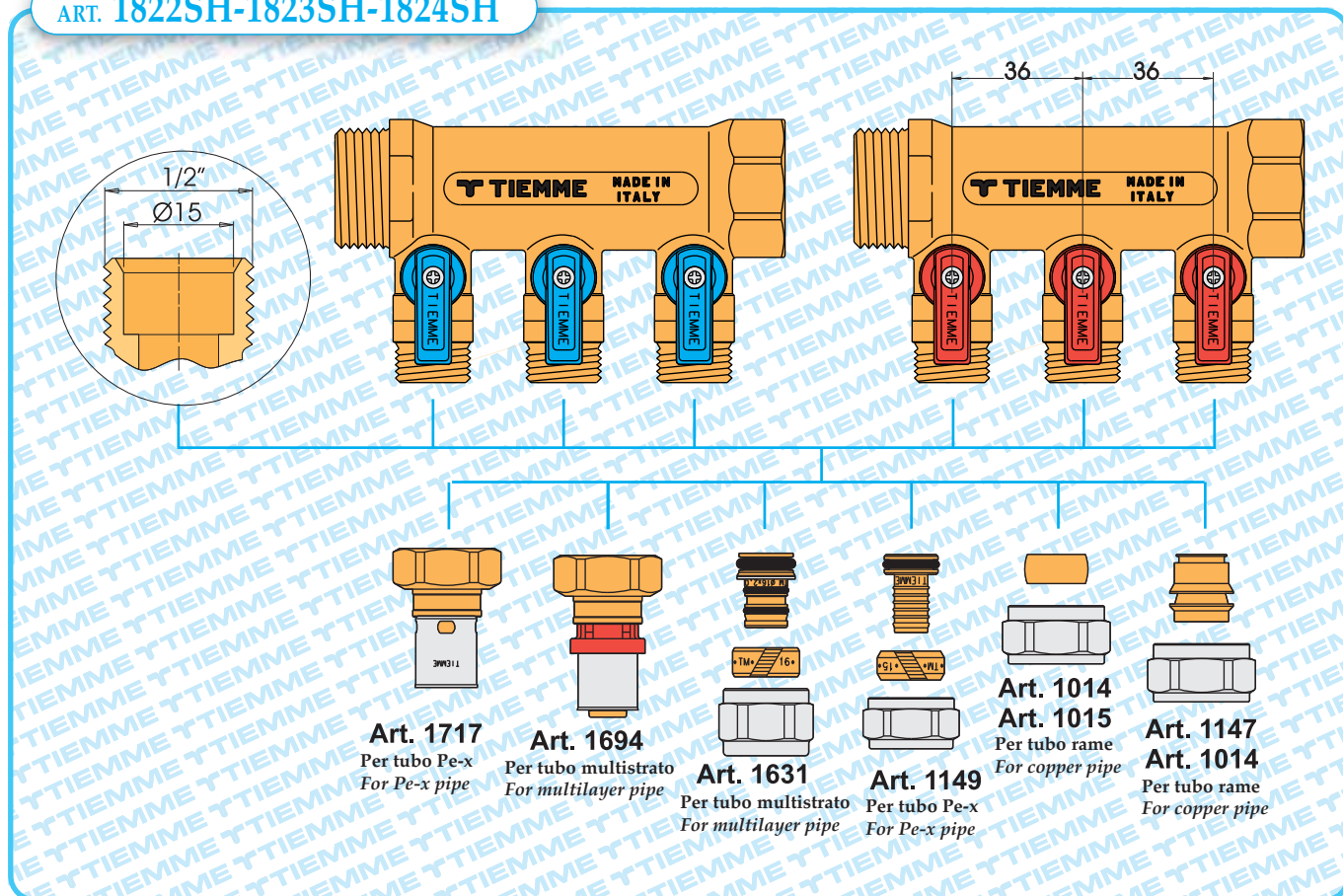

ART. 1842-1843-1844

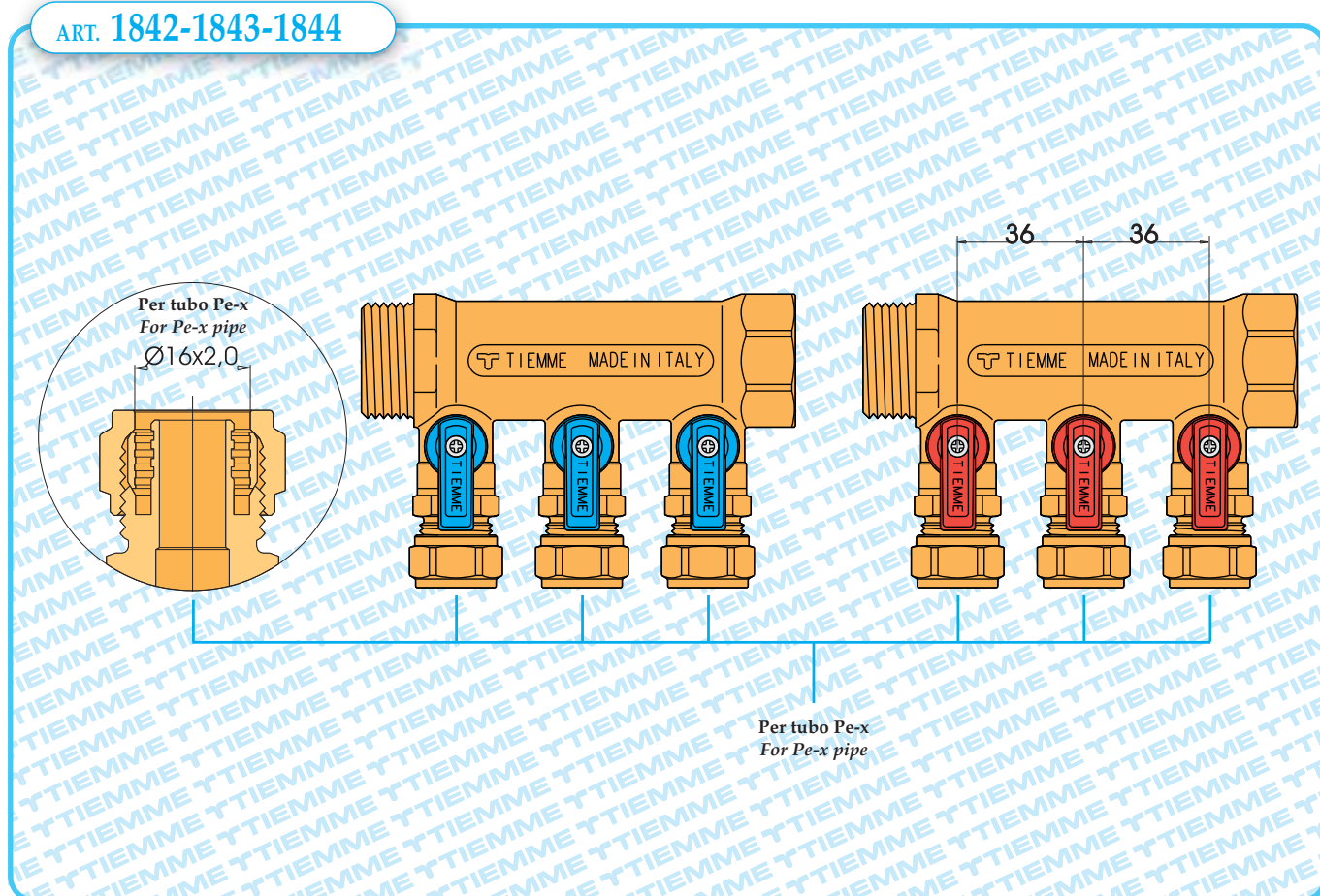

ART. 1861

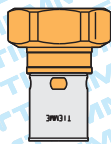
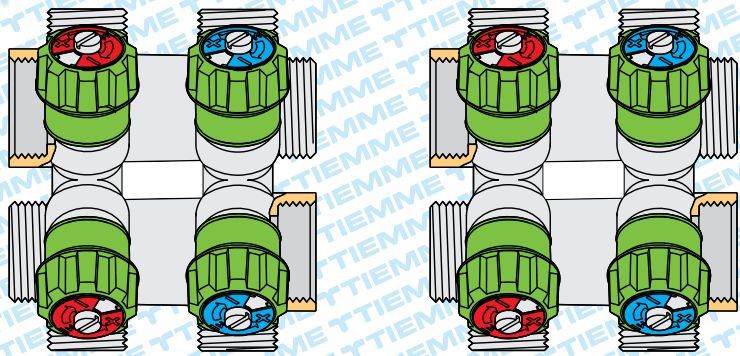
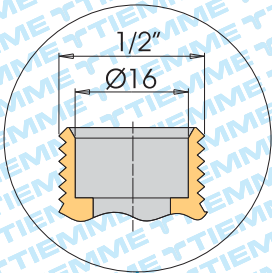

Art. 1716
Per tubo Pe-x
For Pe-x pipe

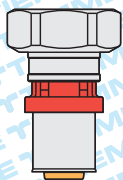

Art. 1668
Per tubo multistrato
For multilayer pipe



Art. 1635
Per tubo multistrato
For multilayer pipe



Art. 1240
Per tubo rame
For copper pipe

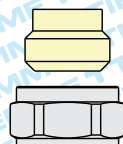

Art. 1233
Art. 1235
Per tubo rame
For copper pipe

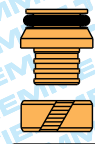

Art. 1435
Per tubo Pe-x
For Pe-x pipe

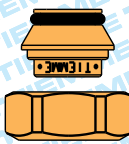

Art. 144 0063
Tappo
Cap

ART. 1866-1868

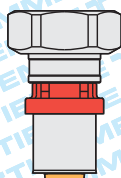
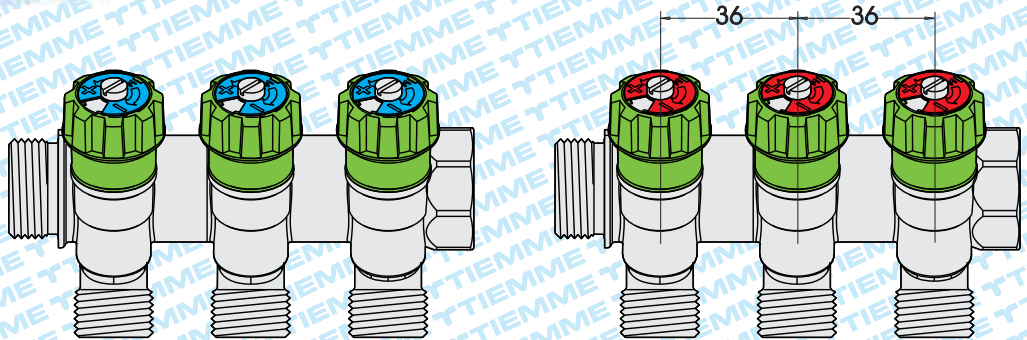
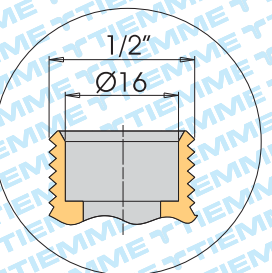

Art. 1668
Per tubo multistrato
For multilayer pipe

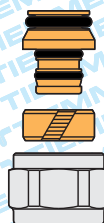

Art. 1635
Per tubo multistrato
For multilayer pipe

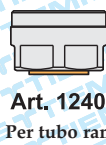

Art. 1240
Per tubo rame
For copper pipe

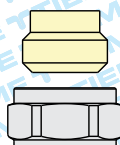

Art. 1233
Art. 1235
Per tubo rame
For copper pipe

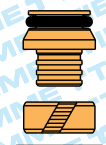

Art. 1435
Per tubo Pe-x
For Pe-x pipe



Art. 144 0063
Tappo
Cap

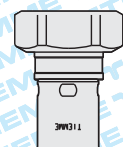

Art. 1716
Per tubo Pe-x
For Pe-x pipe

ART. 1866SH

Dischetti segna utenza
Using marks

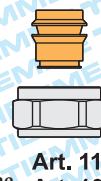
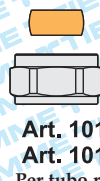
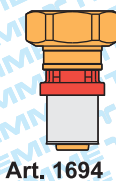
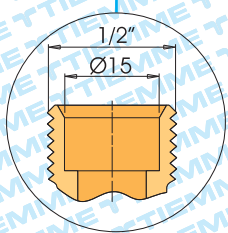
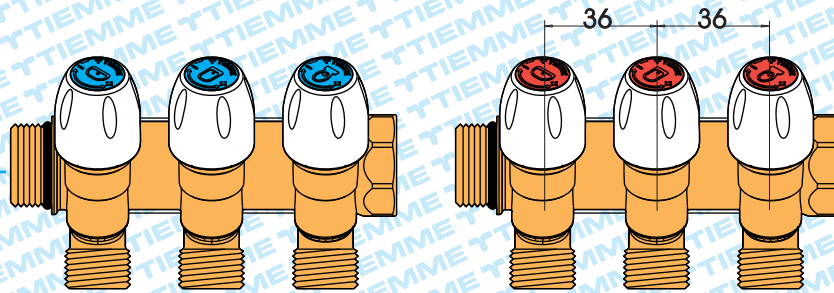
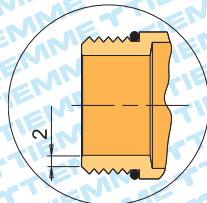

Art. 1717
Per tubo Pe-x
For Pe-x pipe

Art. 1694
Per tubo multistrato
For multilayer pipe

Art. 1631
Per tubo multistrato
For multilayer pipe

Art. 1149
Per tubo Pe-x
For Pe-x pipe

Art. 1014
Art. 1015
Per tubo rame
For copper pipe

Art. 1147
Art. 1014
Per tubo rame
For copper pipe

ART. 1866G16SH

Dischetti segna utenza
Using marks

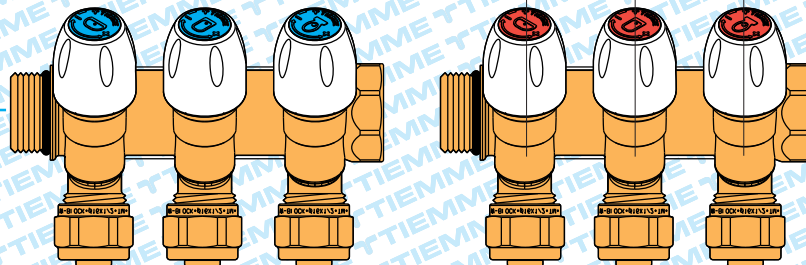
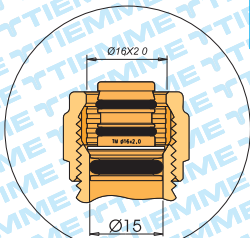
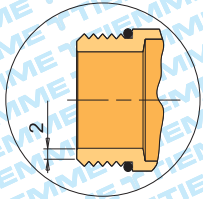

Per tubo multistrato
For multilayer pipe

ART. 1866K-1868K

Dischetti segna utenza
Using marks

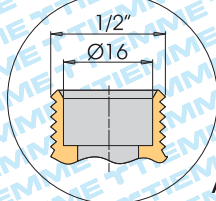
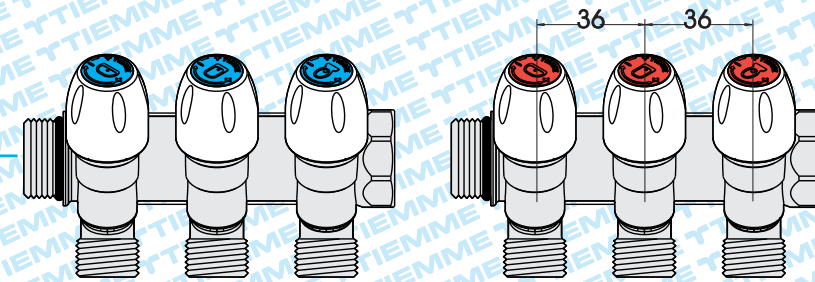
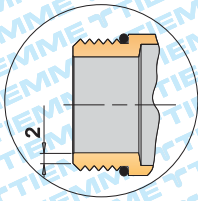

Art. 1668K
Per tubo multistrato
For multilayer pipe



Art. 1635K
Per tubo multistrato
For multilayer pipe

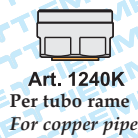

Art. 1240K
Per tubo rame
For copper pipe

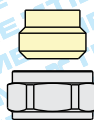

Art. 1233K
Art. 1235K
Per tubo rame
For copper pipe



Art. 1435K
Per tubo Pe-x
For Pe-x pipe

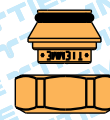

Art. 144 0063
Tappo
Cap

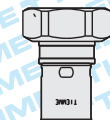

Art. 1716
Per tubo Pe-x
For Pe-x pipe

ART. 1876K

Dischetti segna utenza
Using marks

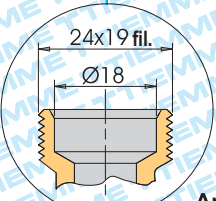
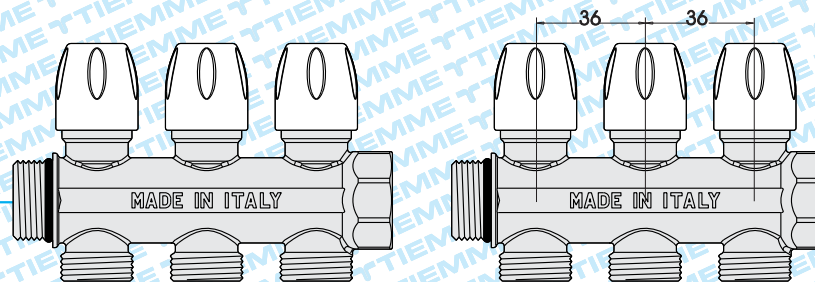
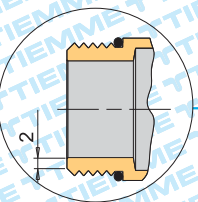

Art. 1666K
Per tubo multistrato
For multilayer pipe



Art. 1633K
Per tubo multistrato
For multilayer pipe

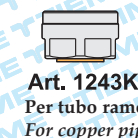

Art. 1243K
Per tubo rame
For copper pipe

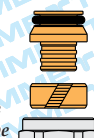

Art. 1433K
Per tubo Pe-x
For Pe-x pipe

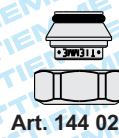

Art. 144 0211
Tappo
Cap

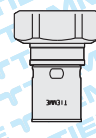

Art. 1716
Per tubo Pe-x
For Pe-x pipe



Art. 144 0104
Adattatore per
sede piana
Flat seat adaptor

ART. 1877K36

Dischetti segna utenza
Diskette marks use

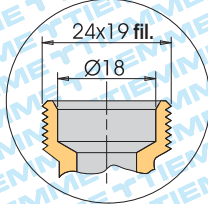
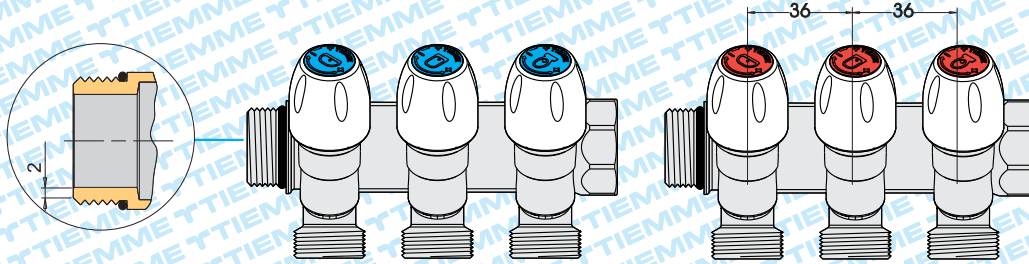

- Art. 1666K
Per tubo multistrato
For multilayer pipe
- Art. 1633K
Per tubo multistrato
For multilayer pipe
- Art. 1243K
Per tubo rame
For copper pipe
- Art. 1433K
Per tubo Pe-x
For Pe-x pipe
- Art. 144 0211
Tappo
Cap
- Art. 1716
Per tubo Pe-x
For Pe-x pipe
- Art. 144 0104
Adattatore per
sede piana
Flat seat adaptor

ART. 1877K50

Dischetti segna utenza
Using marks

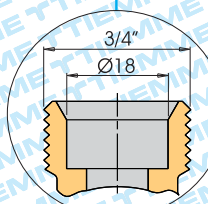
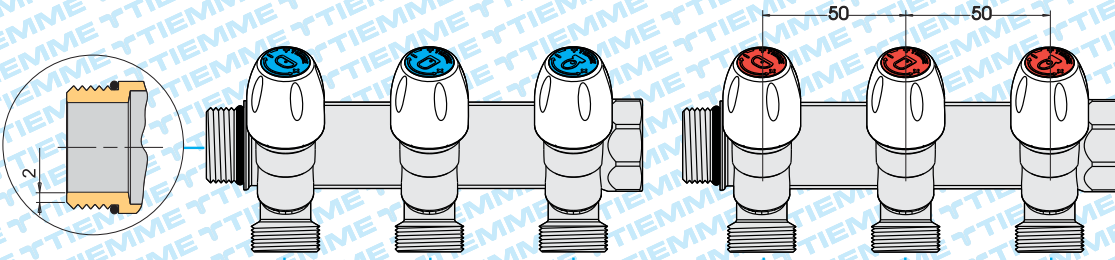

- Art. 1666K
Per tubo multistrato
For multilayer pipe
- Art. 1636K
Per tubo multistrato
For multilayer pipe
- Art. 1241K
Per tubo rame
For copper pipe
- Art. 1436K
Per tubo Pe-x
For Pe-x pipe
- Art. 144 0071
Tappo
Cap
- Art. 1716
Per tubo Pe-x
For Pe-x pipe
- Art. 144 0104
Adattatore per
sede piana
Flat seat adaptor

ART. 1877K50

Dischetti segna utenza
Using marks

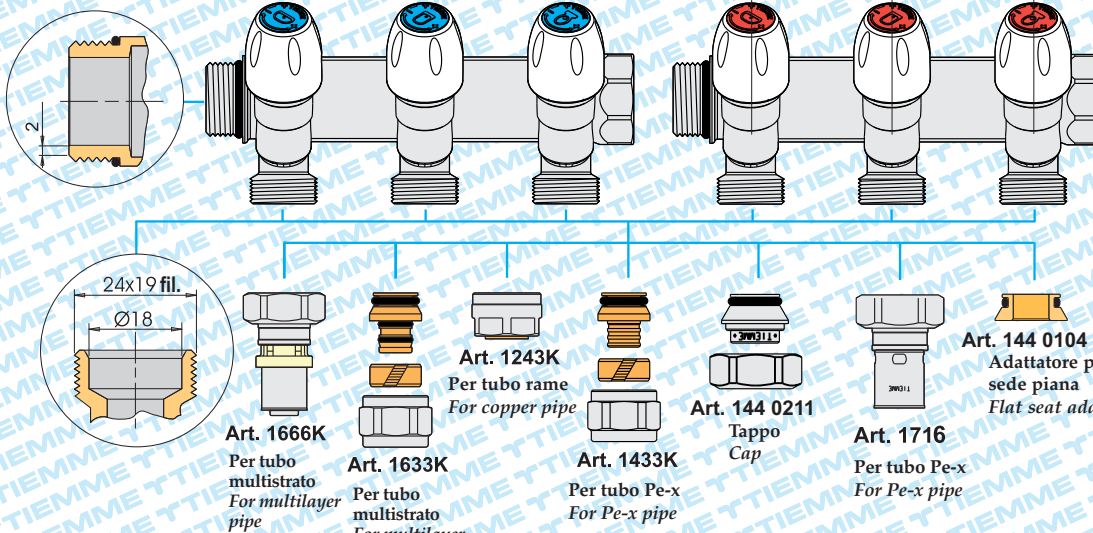

ART. 3033-3035

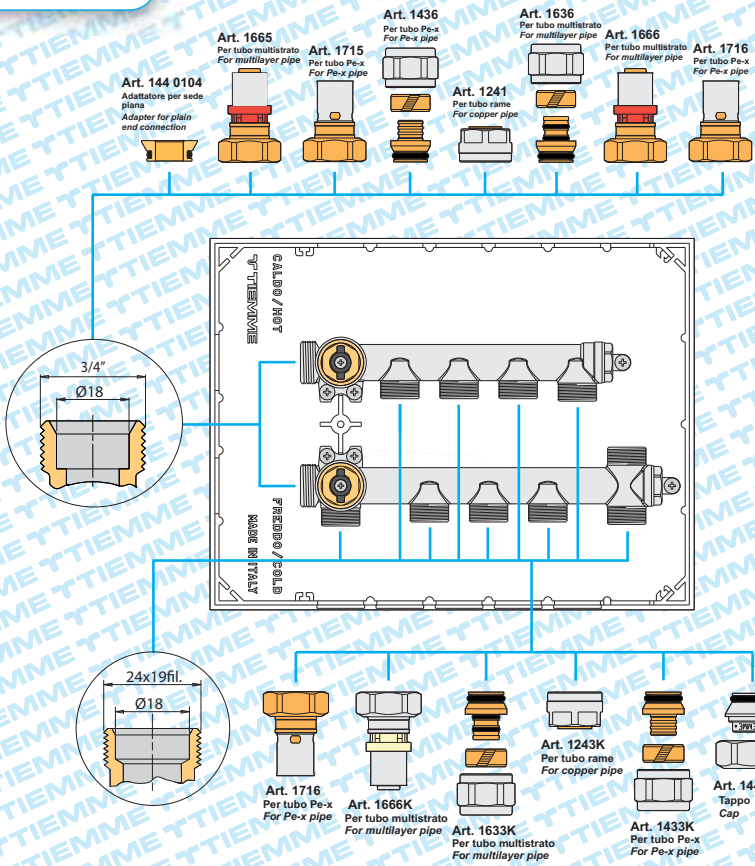

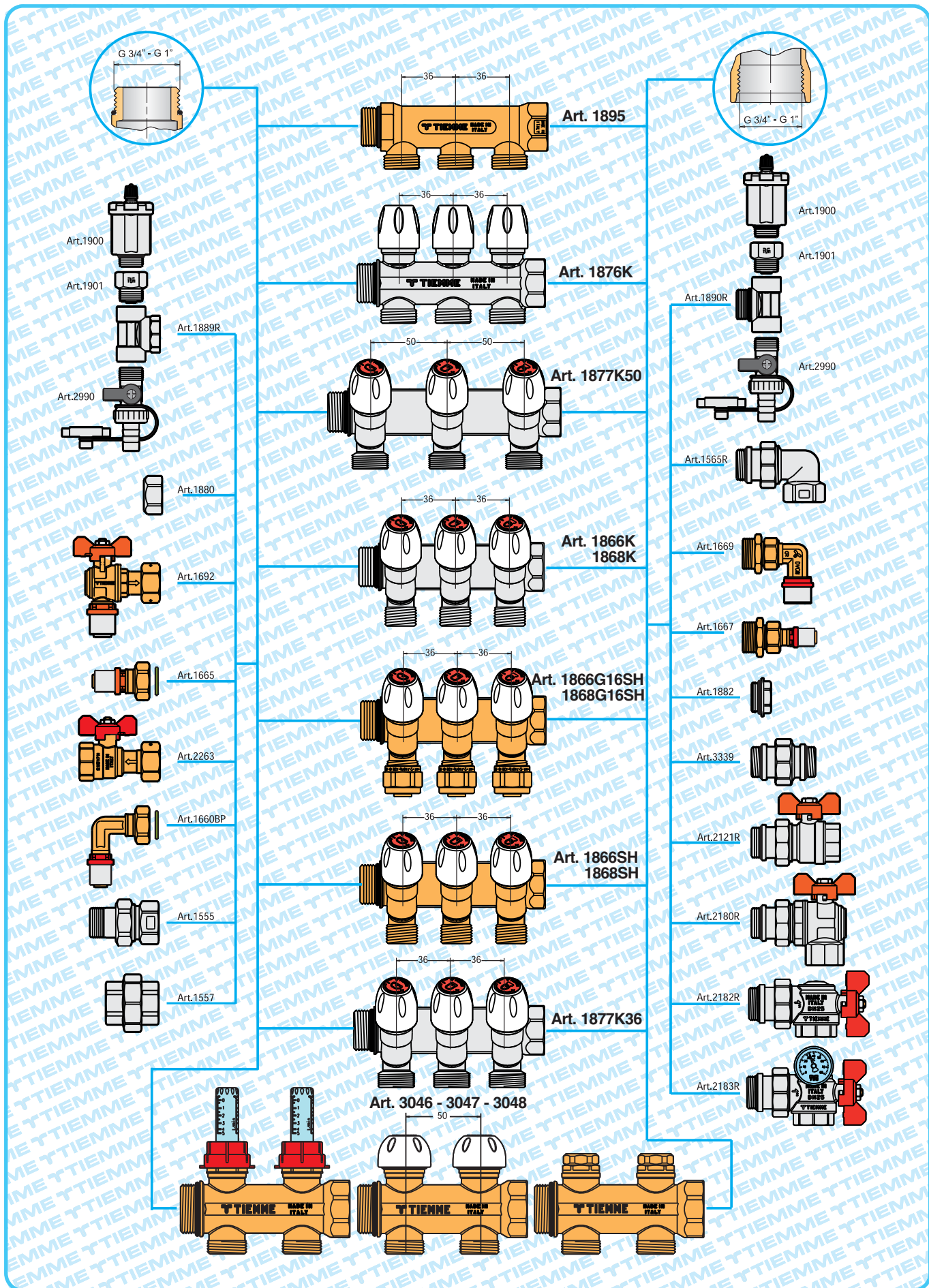

ART. 1883-1884-1885

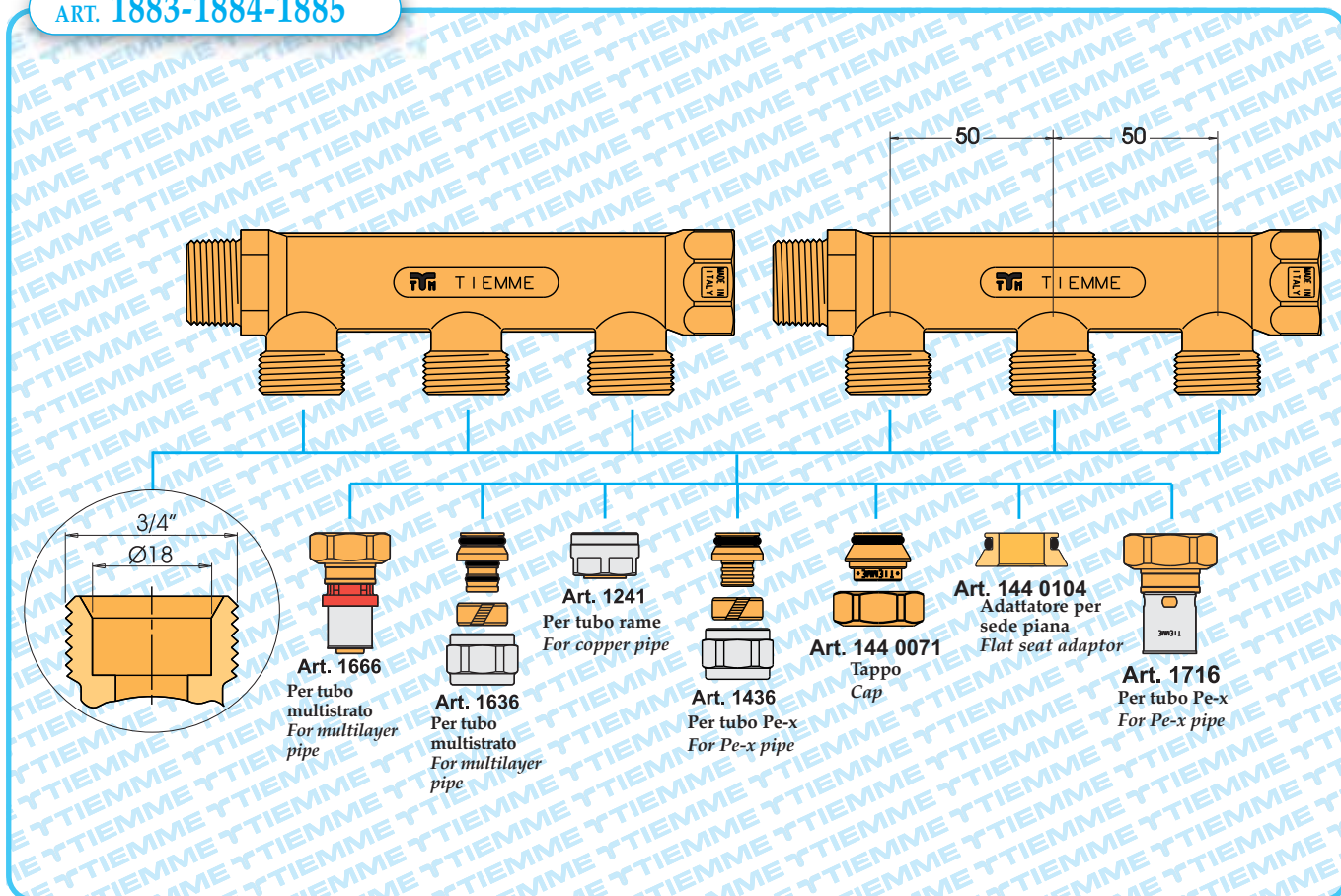

ART. 1895

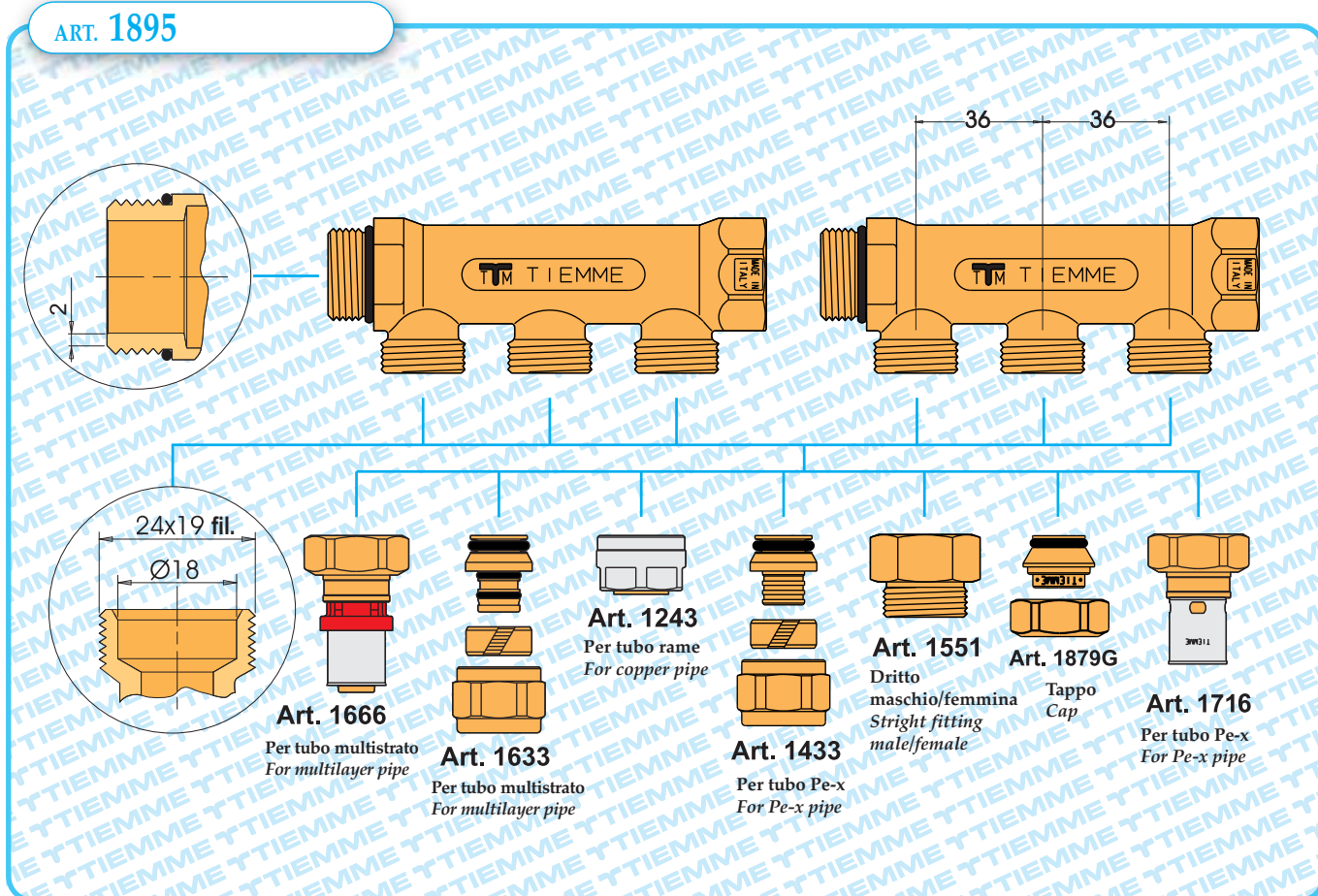

ART. 1905-1906

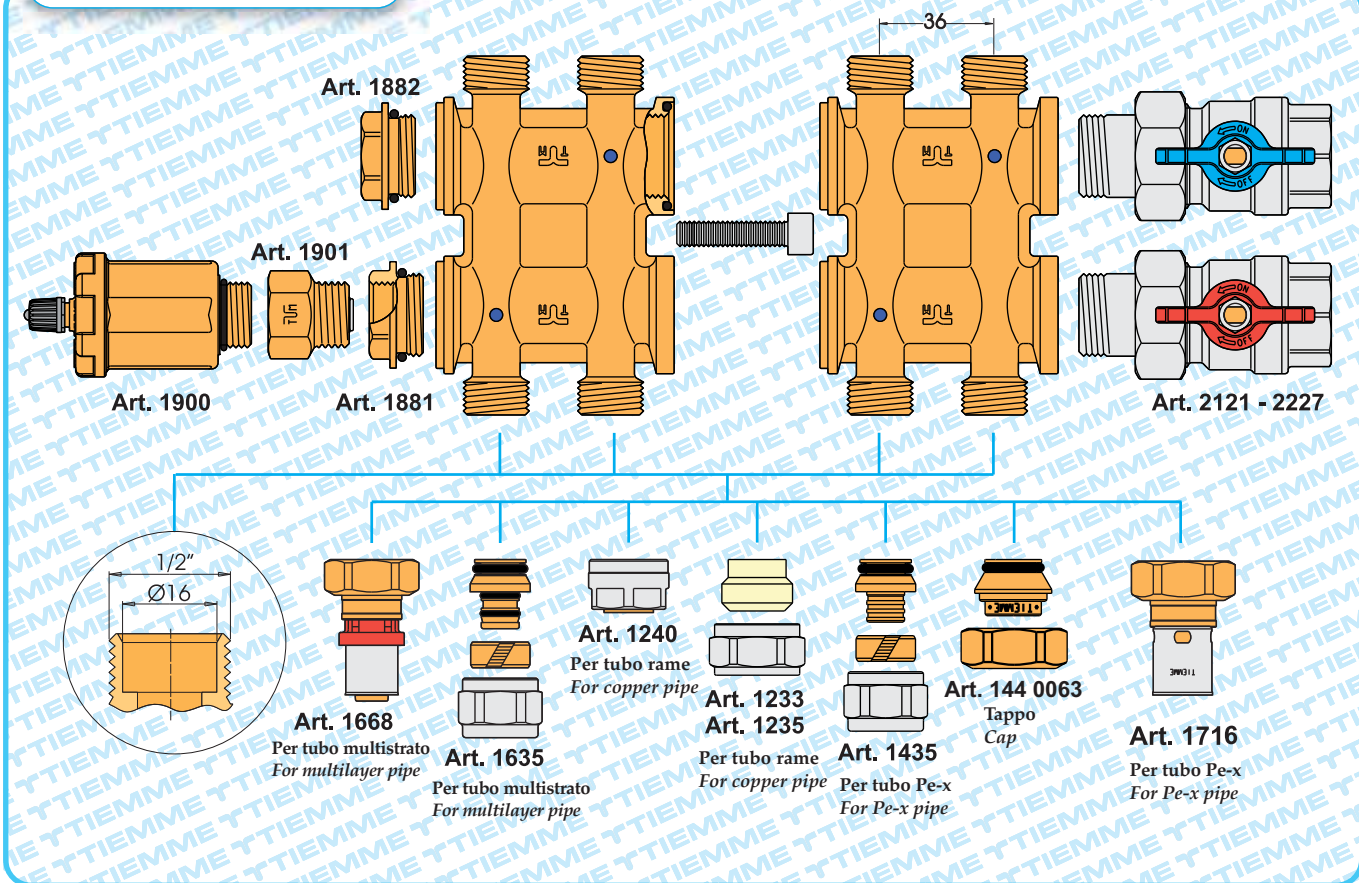

ART. 1905G16SH

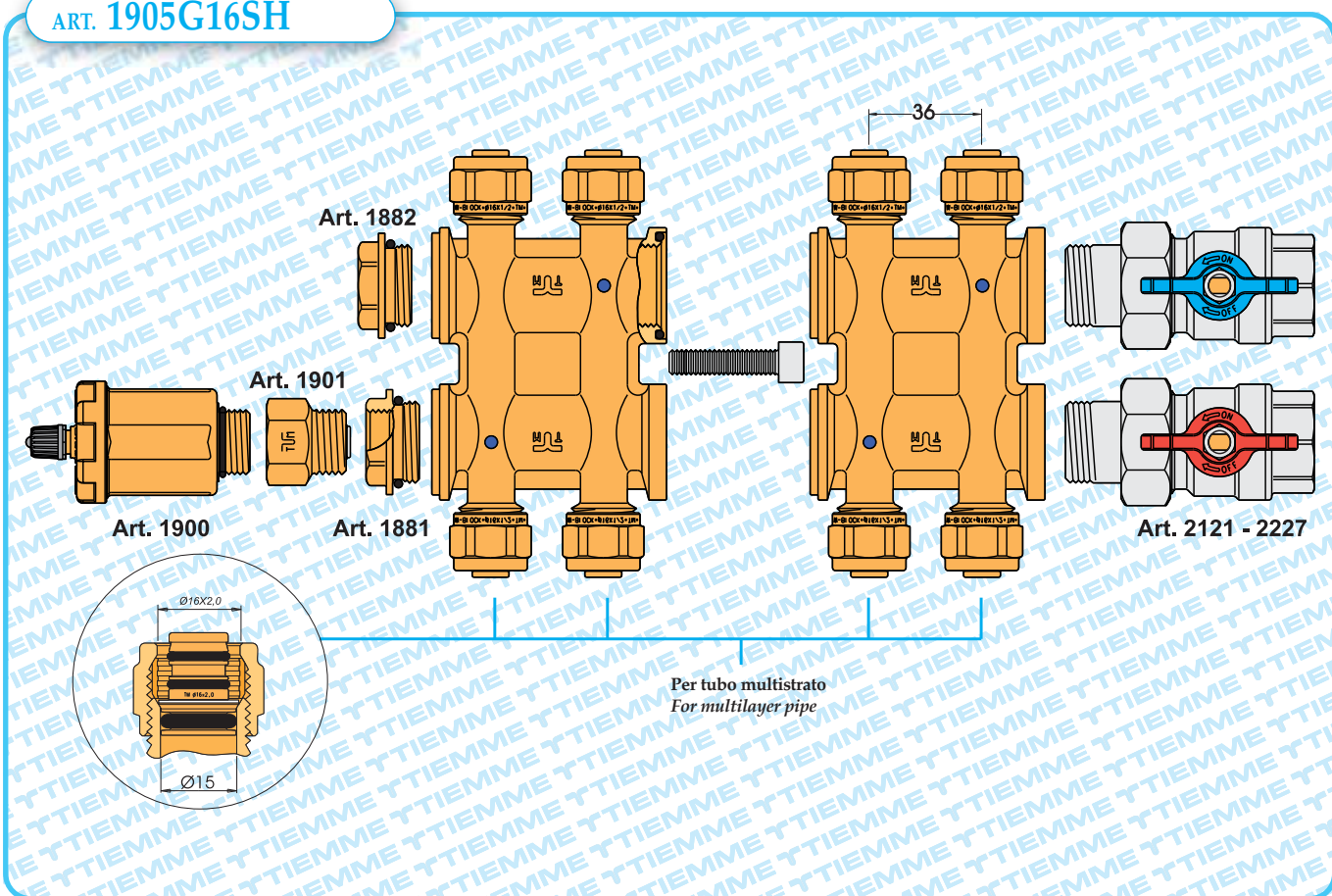

ART. 1908-1909

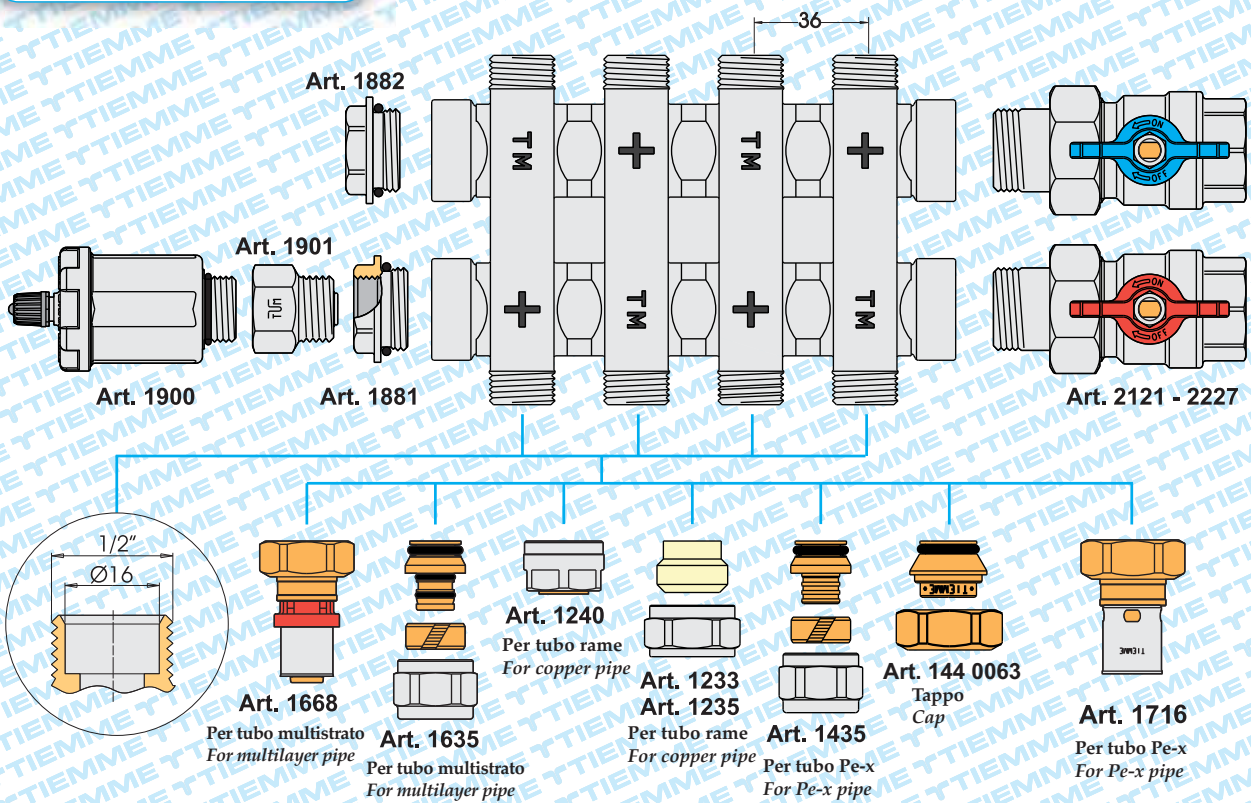

ART. 1912-1922

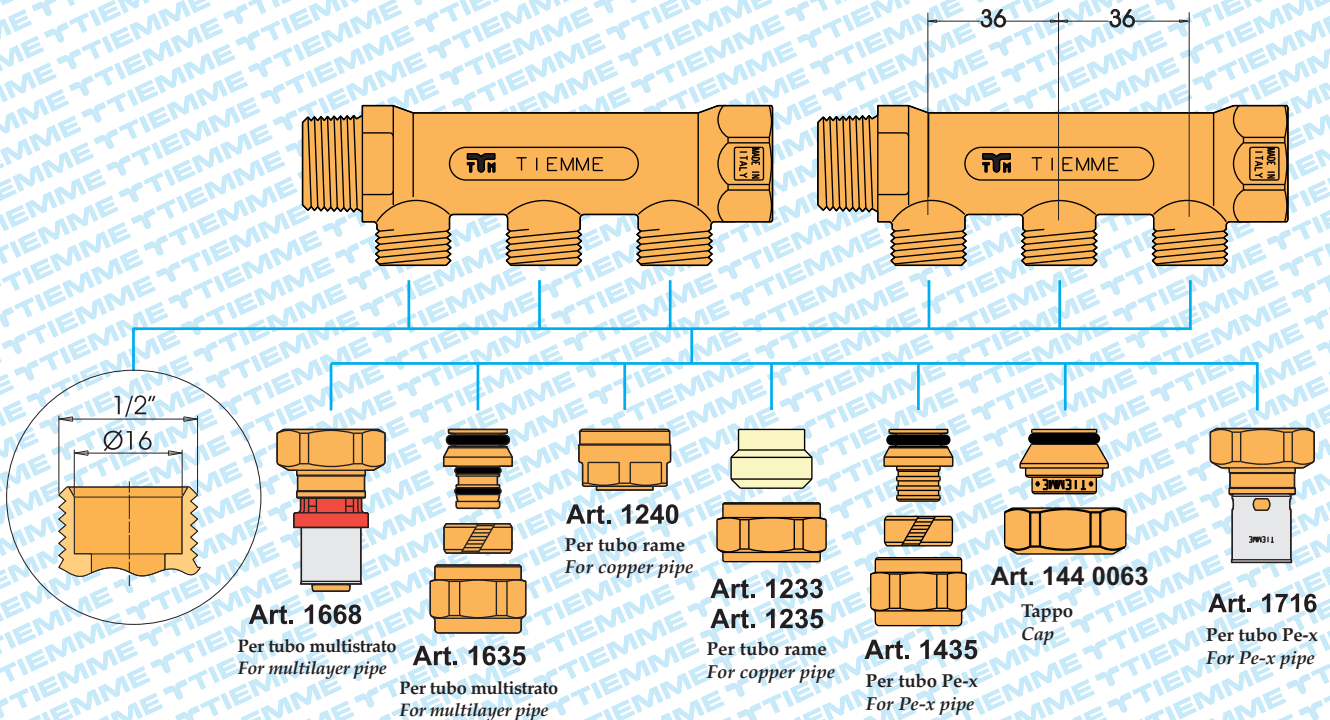

ART. 1912CP

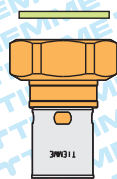
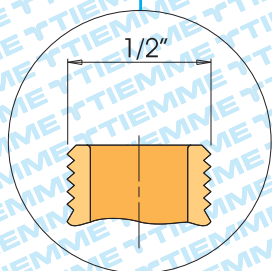
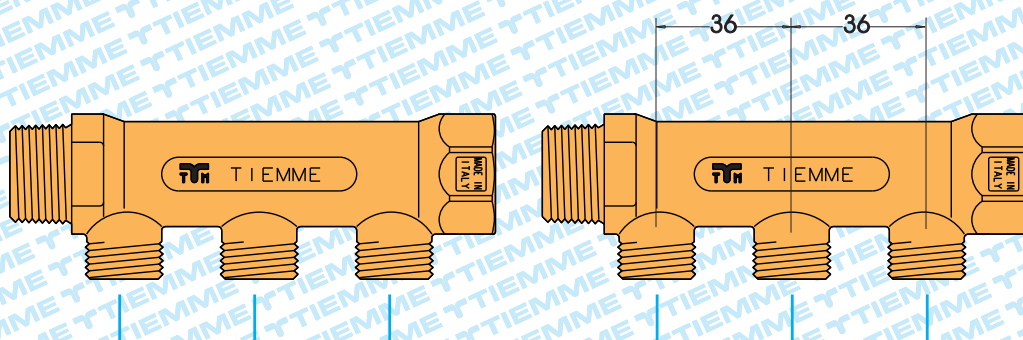

Art. 1715
Per tubo Pe-x
For Pe-x pipe

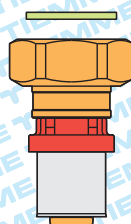

Art. 1665
Per tubo multistrato
For multilayer pipe



Art. 1248
Per tubo multistrato
For multilayer pipe

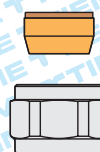

Art. 1249
Per tubo rame
For copper pipe

ART. 1912G16SH

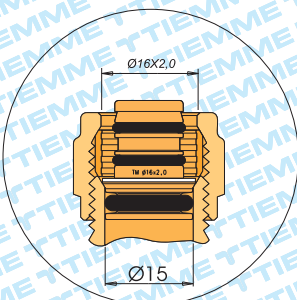
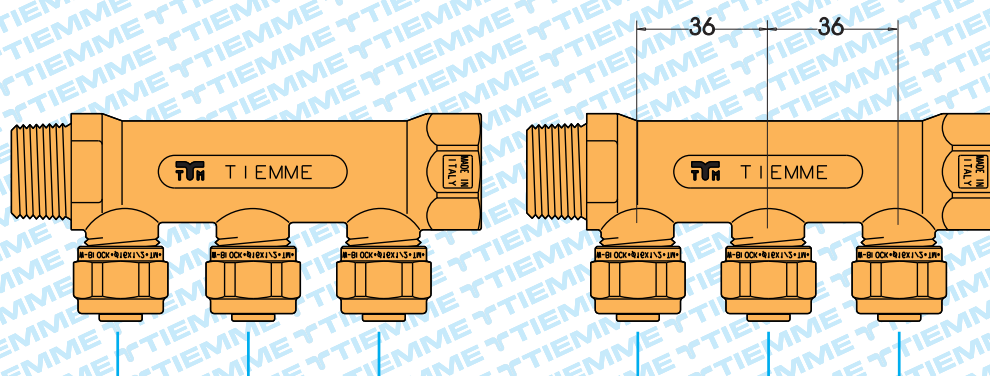

Per tubo multistrato
For multilayer pipe

ART. 1912SH

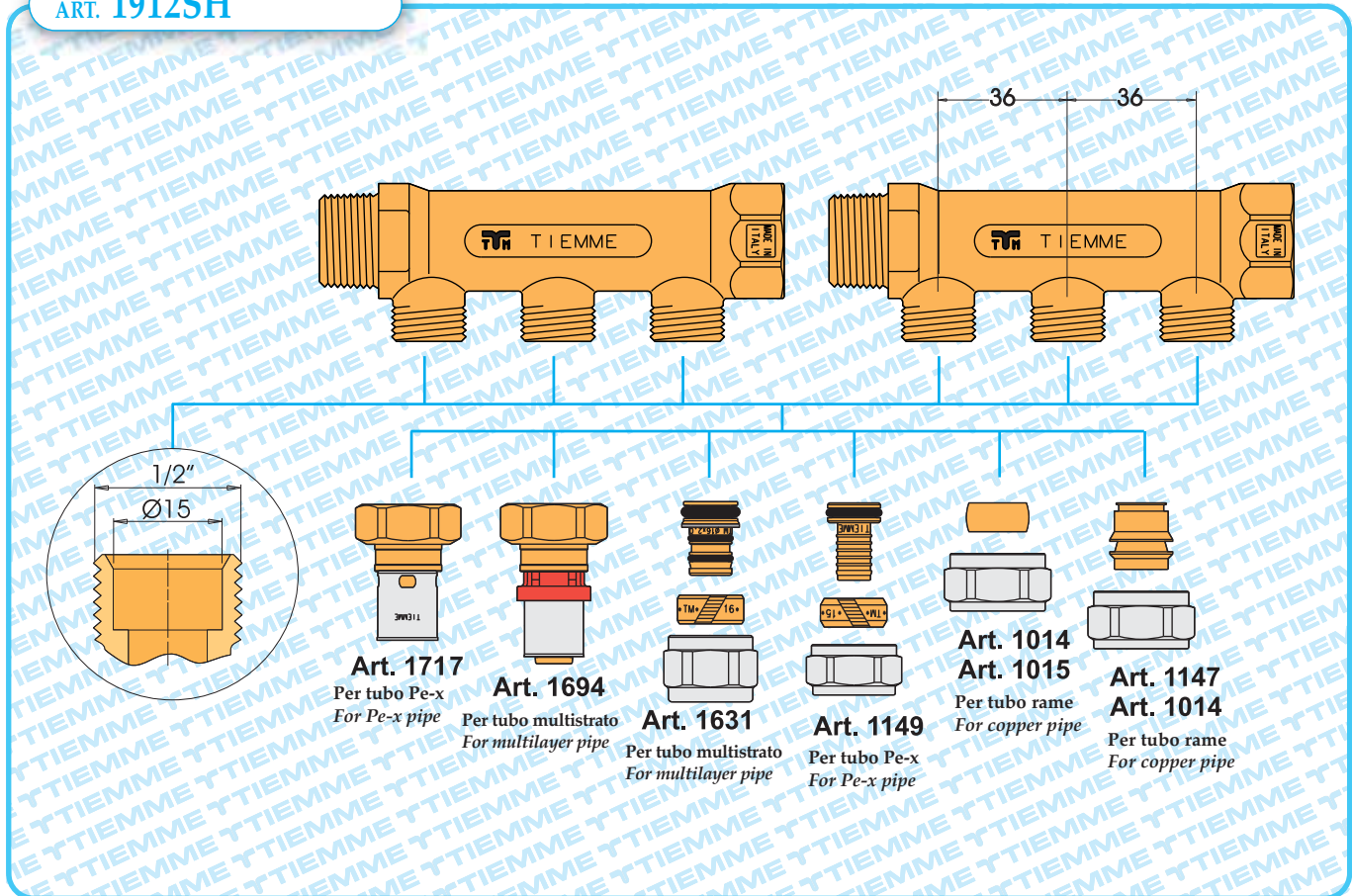

ART. 3036-3037

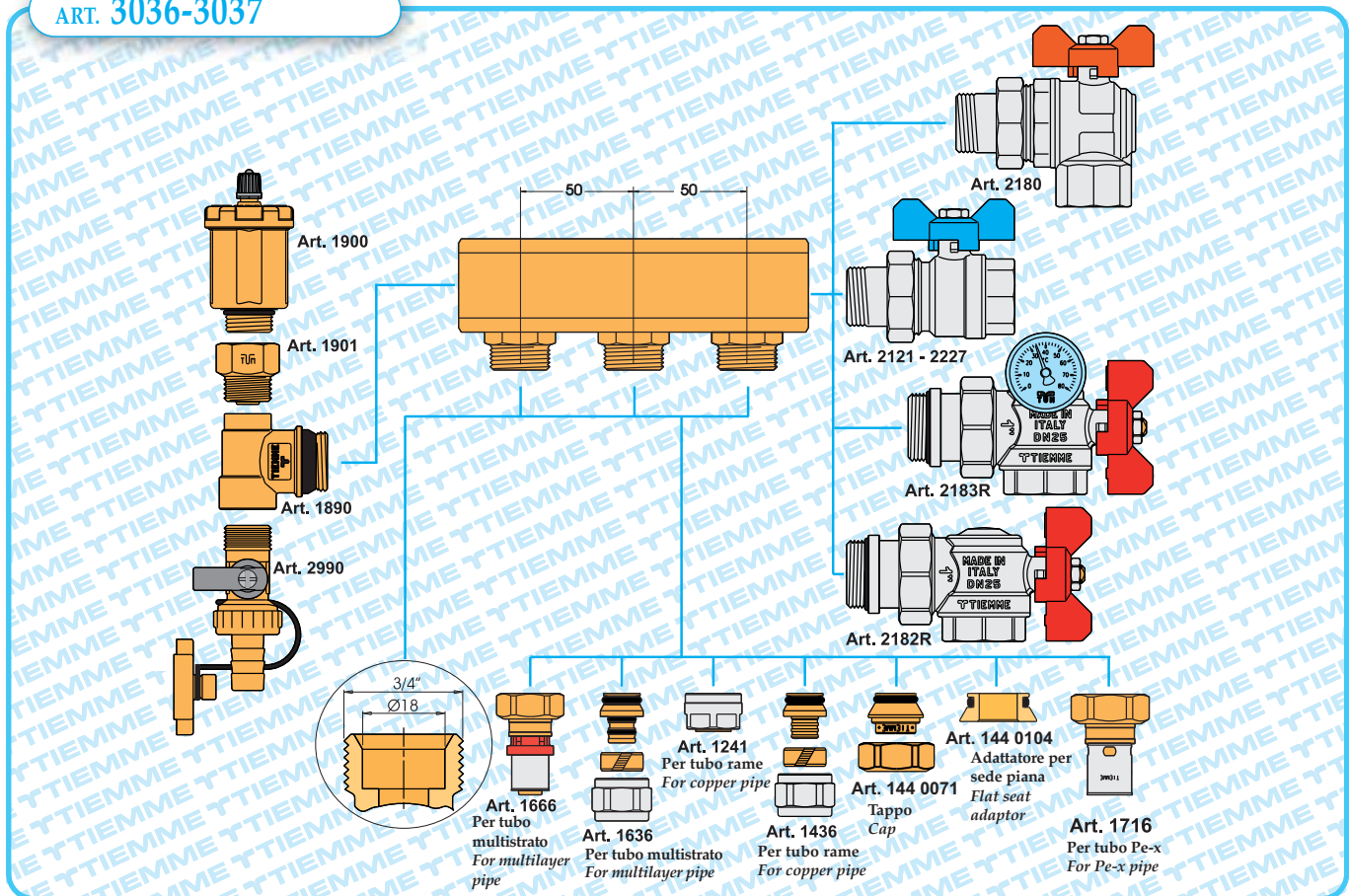

ART. 3039-3040-3042

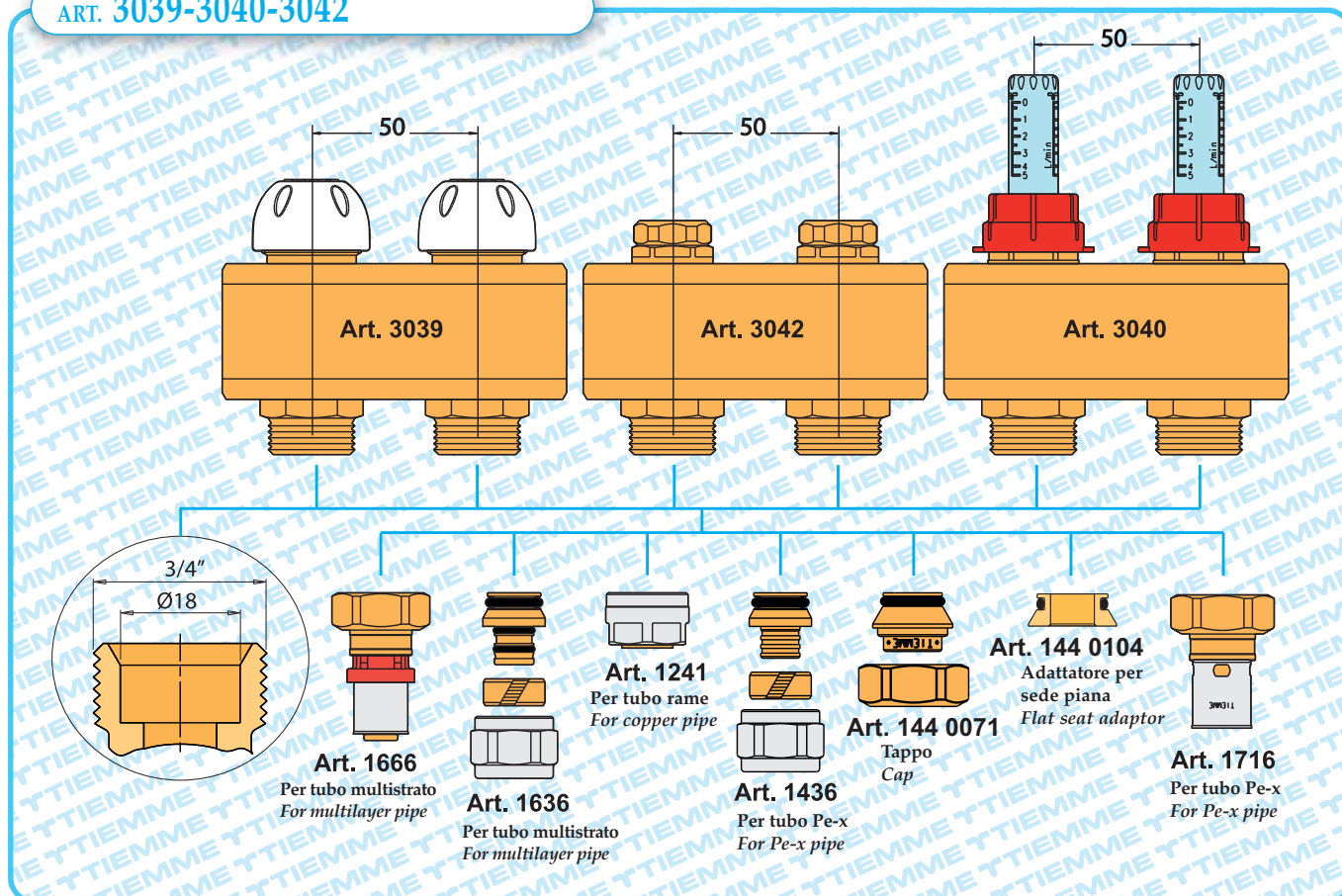

ART. 3046-3047-3048

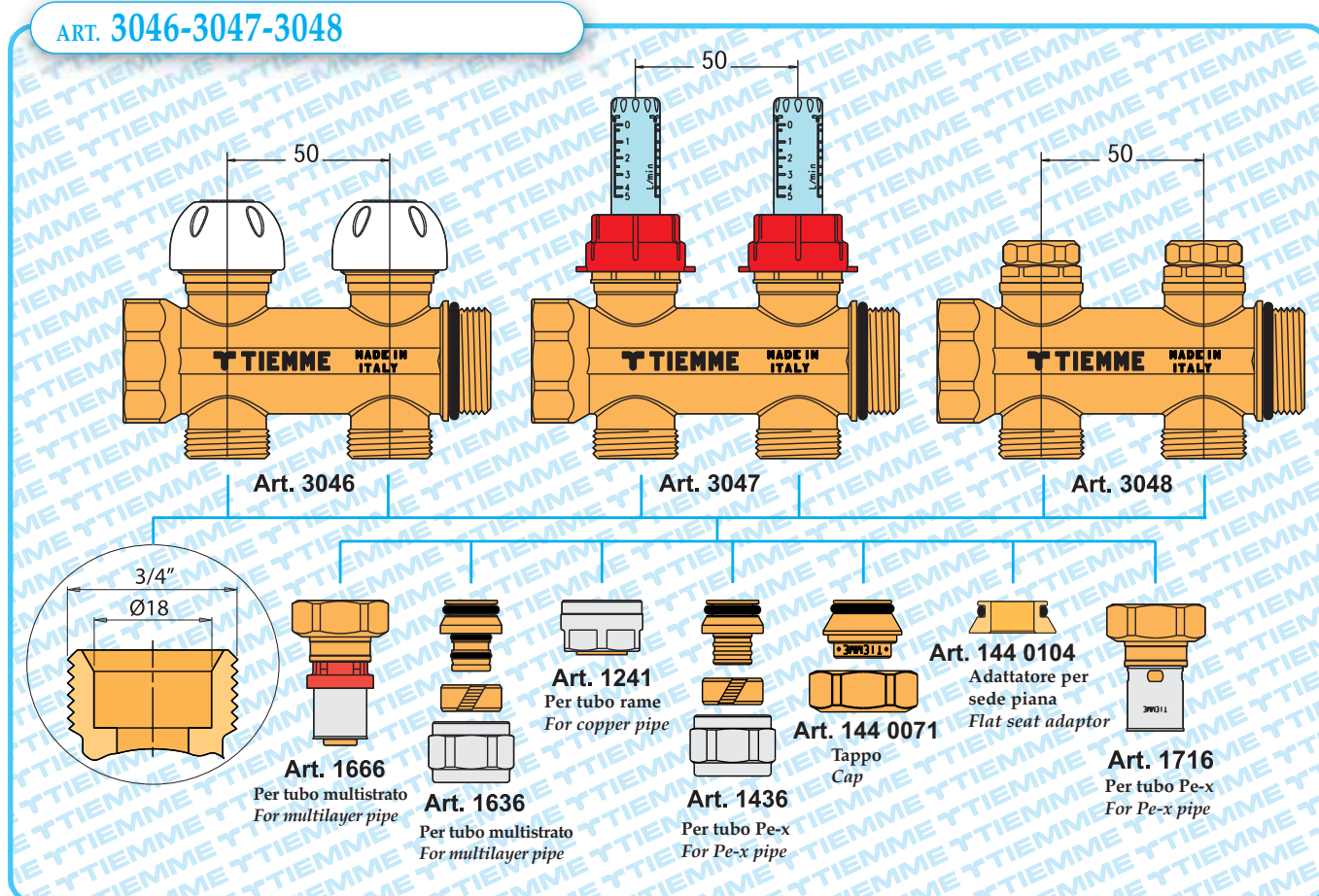

ART. 3370K - 3371K - 3375K - 3376K

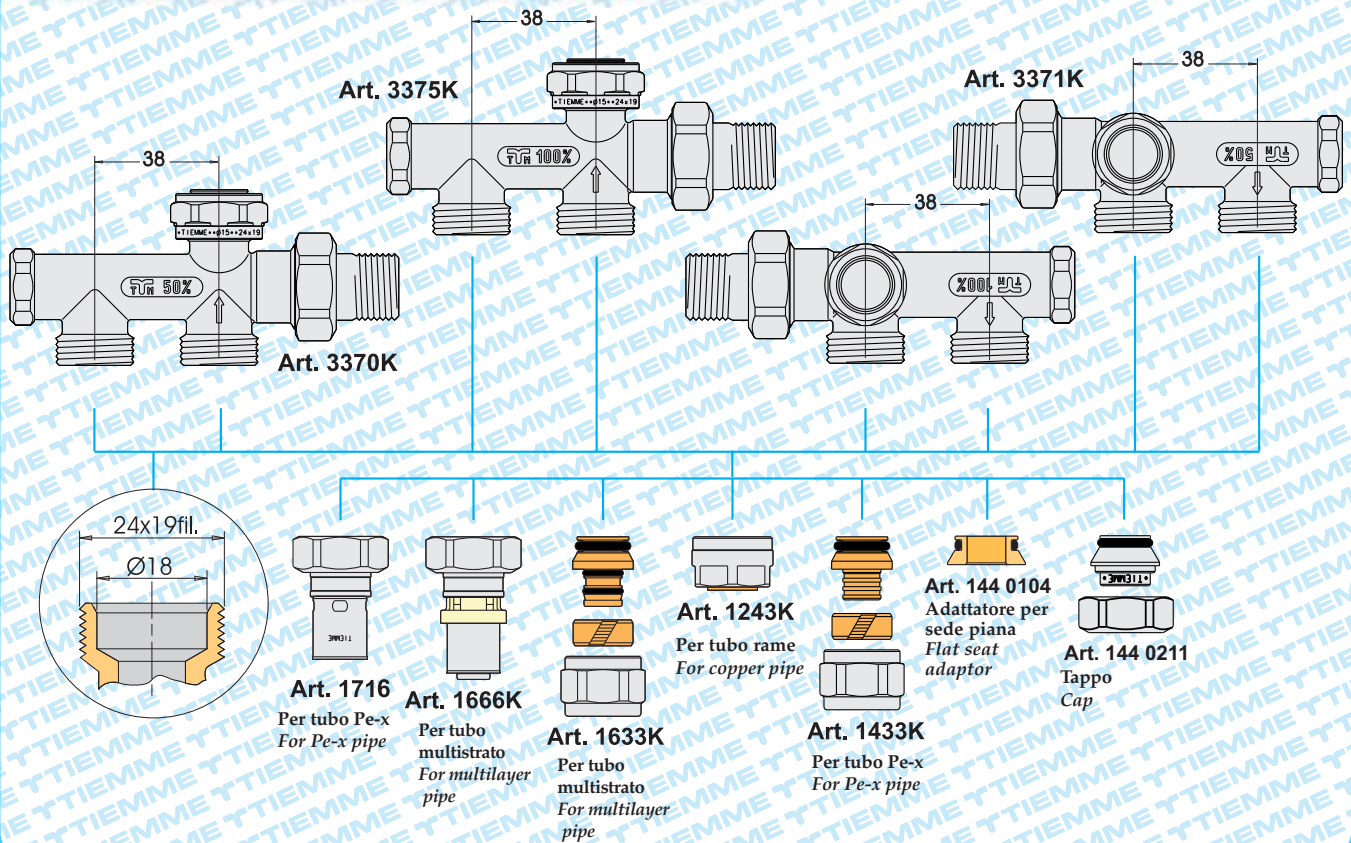

ART. 3382K - 3383K - 3385K

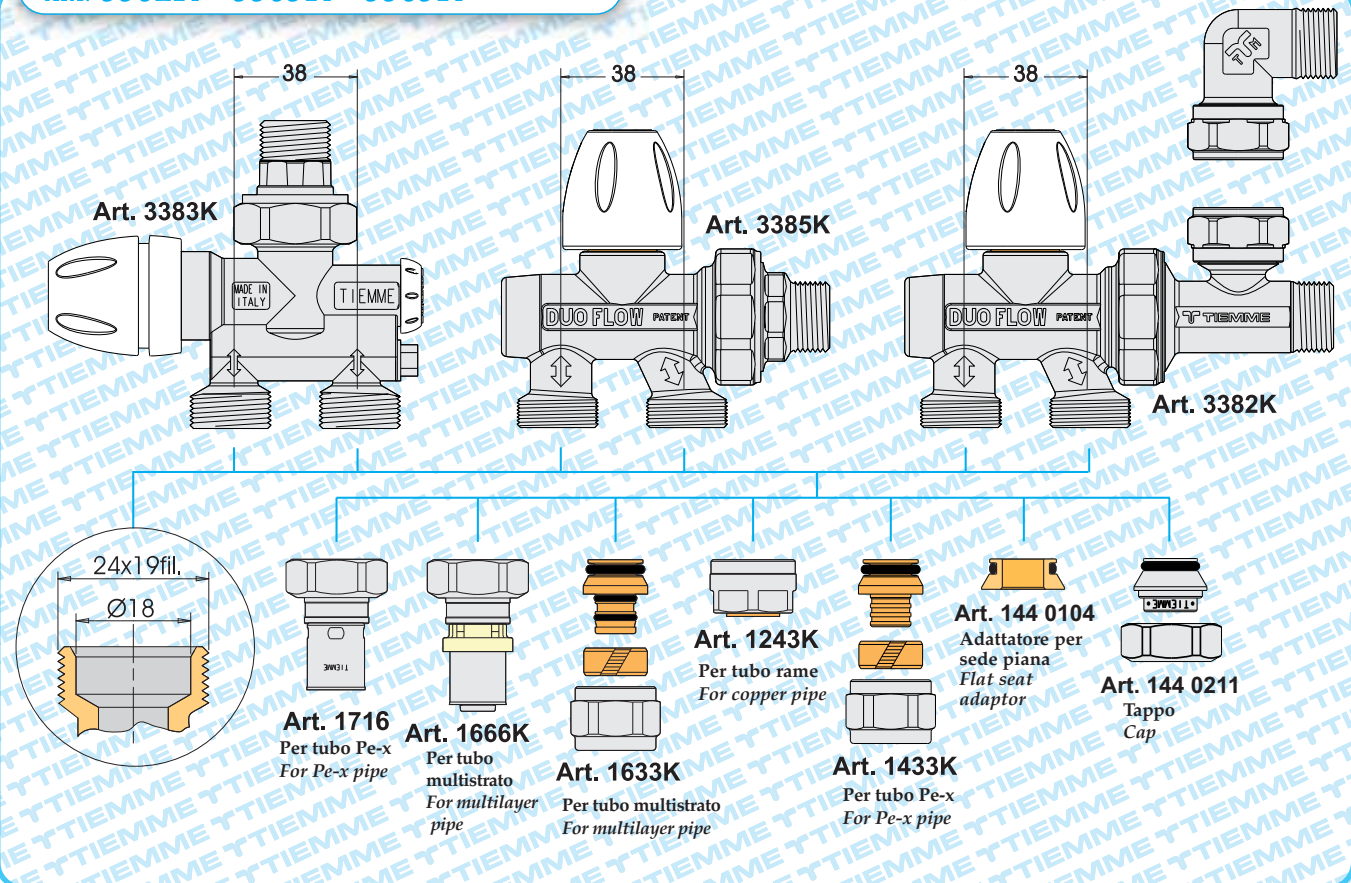

ART. 3391N-3393N

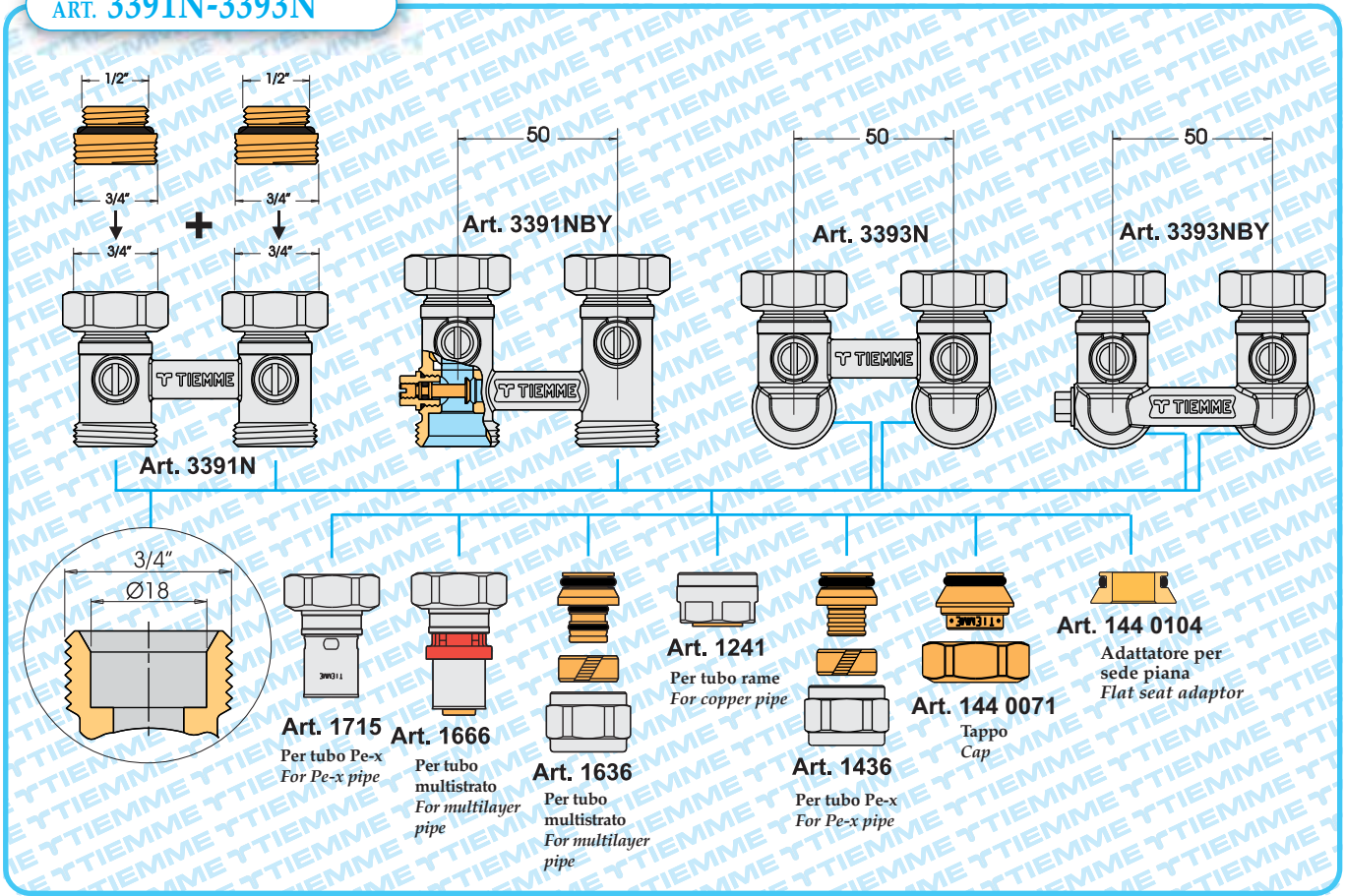

ART. 3391K-3393K

