



# TIEMME

## COLLETTORI CON VALVOLE A SFERA Manifolds with ball valves

### Serie NINOSH

**Collettori "NINO" con attacchi 1/2"x15 e valvola a sfera.**

**Manifold "NINO" with connections 1/2"x15 and ball valve.**

I collettori di distribuzione "NINO" sono generalmente utilizzati nelle reti di distribuzione di acqua calda e fredda. Grazie alla loro configurazione permettono l'alimentazione in parallelo delle utenze per acqua calda e/o fredda riducendo al minimo le perdite di carico.

I collettori sono prodotti in conformità alle normative in materia e sono certificati relativamente alla composizione chimica dei materiali impiegati ed a livello dimensionale.

The distribution manifolds "NINO" are typically used for hot and cold water distribution.

Due to the configuration they may be used to distribute cold/hot water in parallel reducing at minimum the pressure drop.

The manifolds are produced according to the relevant rules and are certified for material chemical composition and dimensional request.



Per la gamma completa vedere il catalogo / For complete range see catalogue



Certificazioni / Certifications



#### Caratteristiche Tecniche

Temperatura max di esercizio: 110°C  
 Temperatura min di esercizio: -20°C  
 Pressione max di esercizio: 16 bar  
 Filettature : maschio UNI ISO 7/1 R conica  
 femmina UNI ISO 7/1 Rp cilindrica

#### Technical Features

Maximum temperature: 110°C  
 Minimum temperature: -20°C  
 Maximum operating pressure: 16 bar  
 Threads: male UNI ISO 7/1 R conical  
 female UNI ISO 7/1 Rp parallel

Descrizione	Materiale	Trattamento
Corpo	Ottone CW617N - EN12165	-
Sfera	Ottone CW617N - EN12164	Cromata
Stelo	Ottone CW617N - EN12164	-
O-rings	Gomma nitrilica NBR	-
Guarnizioni laterali	P.T.F.E.	-
Leva	Alluminio	Verniciata rossa o blu
Vite	Acciaio	-

Description	Material	Treatment
Body	CW617N-EN12165 brass	-
Ball	CW617N-EN12164 brass	Chrome plated
Stem	CW617N-EN12164 brass	-
O-rings	Nitrile Rubber NBR	-
Side washers	P.T.F.E.	-
Handle	Aluminium	Painted red or blue
Screw	Steel	-

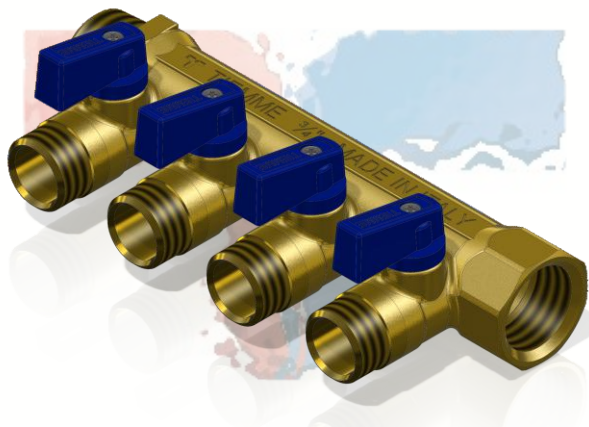

TIEMME Raccorderie S.p.A. si riserva di apportare modifiche in qualsiasi momento senza preavviso.  
 TIEMME Raccorderie S.p.A. reserves the right to modify contents in any time without prior advise.  
 È vietata qualsiasi forma di riproduzione, se non autorizzata.  
 It is forbidden any reproduction unless under TIEMME autorization



**TIEMME Raccorderie S.p.A.**  
 Via Cavallera 6/A (Loc. Barco) - 25045 Castegnato (Bs) - Italy  
 Tel +39 030 2142211 R.A. - Fax +39 030 2142206  
 info@tiemme.com - www.tiemme.com





# TIEMME

## COLLETTORI CON VALVOLE A SFERA Manifolds with ball valves

### Serie NINOSH

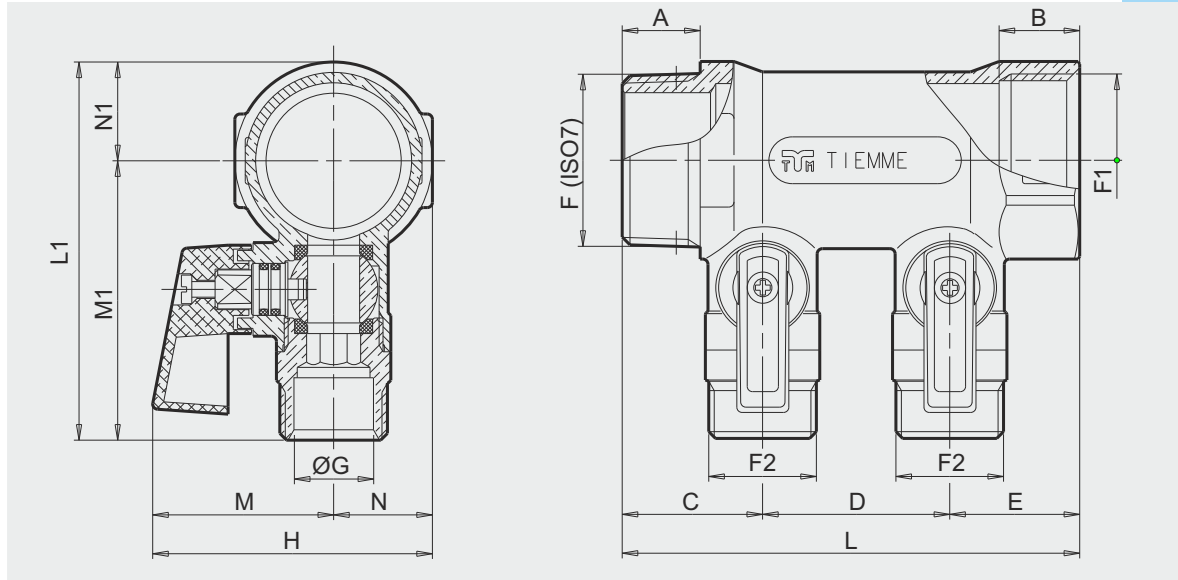

#### Tabella dimensioni

#### Sizes table

Codice/ Code	Size	A	B	C	D	E	F	F1	F2	G	H	L	L1	M	M1	N	N1
1822G150402SH	3/4"	16,5	16,5	28,5	36,0	27,0	3/4"	3/4"	1/2"	15,2	51,0	91,5	66,5	35,0	50,5	16,0	16,0
1823G150403SH	3/4"	16,5	16,5	28,5	36,0	27,0	3/4"	3/4"	1/2"	15,2	51,0	127,5	66,5	35,0	50,5	16,0	16,0
1824G150404SH	3/4"	16,5	16,5	28,5	36,0	27,0	3/4"	3/4"	1/2"	15,2	51,0	163,5	66,5	35,0	50,5	16,0	16,0

#### Guida alle connessioni Fitting guide

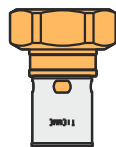
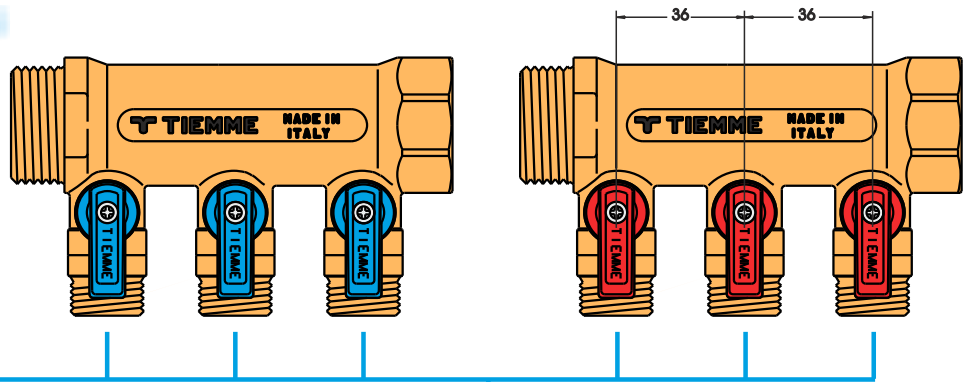
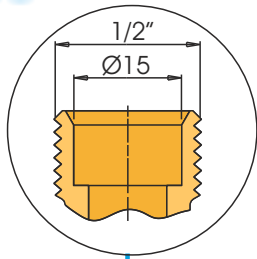

**Art. 1717**  
Per tubo Pe-x  
For Pe-x pipe

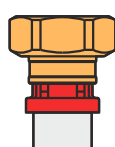

**Art. 1694**  
Per tubo multistrato  
For multilayer pipe



**Art. 1631**  
Per tubo multistrato  
For multilayer pipe



**Art. 1149**  
Per tubo Pe-x  
For Pe-x pipe



**Art. 1014**  
Per tubo rame  
For copper pipe



**Art. 1147**  
**Art. 1014**  
Per tubo rame  
For copper pipe



TIEMME Raccorderie S.p.A.  
Via Cavallera 6/A (Loc. Barco) - 25045 Castegnato (Bs) - Italy  
Tel +39 030 2142211 R.A. - Fax +39 030 2142206  
info@tiemme.com - www.tiemme.com

©TIEMME Raccorderie S.p.A. NINOSH Rev. D. 07-12



TIEMME Raccorderie S.p.A. si riserva di apportare modifiche in qualsiasi momento senza preavviso.  
TIEMME Raccorderie S.p.A. reserves the right to modify contents in any time without prior advise.  
È vietata qualsiasi forma di riproduzione, se non autorizzata.  
is forbidden any reproduction unless under TIEMME autorization





# TIEMME

## COLLETTORI CON VALVOLE A SFERA Manifolds with ball valves

### Serie NINOSH

Cassette utilizzabili  
Boxes used

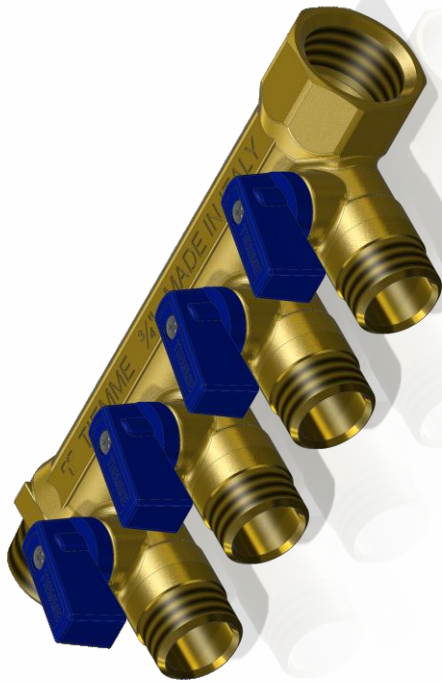

ART. 1939/1940

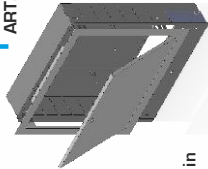

Cassetta regolabile  
in altezza e  
profondità  
Metallic box with  
height and  
depth adjustable

+

ART. 1870



Supporto per collettori  
Holding set for manifolds

ART. 1939/1940

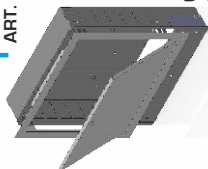

Cassetta regolabile in  
altezza e profondità  
Metallic box with height and  
depth adjustable

+

ART. 1877SKIT



Kit di fissaggio  
per collettori  
Manifolds bracket

ART. 1920-1930

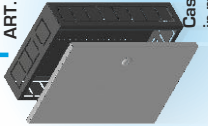

Cassetta universale  
in metallo  
Universal metallic box

+

11 ART. 1807

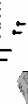

Supporti per collettori  
Holding set for manifolds

ART. 1810

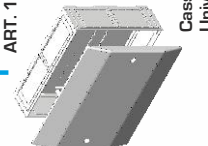

Cassetta universale  
Universal box

+

11 ART. 1807

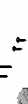

Supporti per collettori  
Holding set for manifolds

ART. 1910P

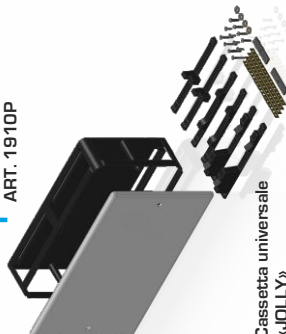

Cassetta universale  
«JOLLY» Universal  
box



ORIGINAL ITALIAN TRADEMARK

TIEMME Raccorderie S.p.A.  
Via Cavallera 6/A (Loc. Barco) - 25045 Castegnato (Bs) - Italy  
Tel +39 030 2142211 R.A. - Fax +39 030 2142206  
info@tiemme.com - www.tiemme.com

©TIEMME Raccorderie S.p.A. NINOSH Rev. D. 07-12

