



# TIEMME

## COLLETTORI CON RUBINETTO

### Manifolds with stop cocks

## Serie MAXIMA

Collettori lineari componibili con derivazioni dotate di rubinetto di chiusura. Disponibile con mandata da 3/4" od 1" e 2, 3, 4 o 5 attacchi con interasse 36mm o 50mm.

Modular linear manifolds with ways provided of stop cocks. Available with delivery 3/4" or 1" and 2, 3, 4 or 5 pipe connections with distance between axis of 36mm or 50mm..

I collettori di distribuzione "MAXIMA" sono generalmente utilizzati nelle reti di distribuzione di acqua calda e fredda. Grazie alla loro configurazione permettono l'alimentazione in parallelo delle utenze per acqua calda e/o fredda riducendo al minimo le perdite di carico. I collettori sono prodotti in conformità alle normative in materia e sono certificati relativamente alla composizione chimica dei materiali impiegati ed a livello dimensionale.

The distribution manifolds "MAXIMA" are typically used for hot and cold water distribution. Due to the configuration they may be used to distribute cold/hot water in parallel reducing at minimum the pressure drop. The manifolds are produced according to the relevant rules and are certified for material chemical composition and dimensional request.



Per la gamma completa vedere il catalogo / For complete range see catalogue

Certificazioni / Certifications

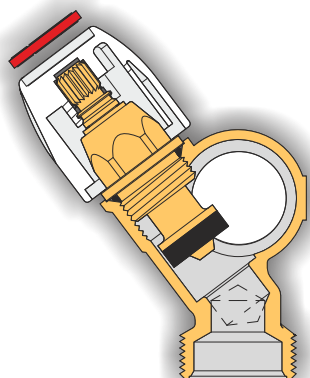

#### Caratteristiche Tecniche

Temperatura max di esercizio: 110°C  
Temperatura min di esercizio: -20°C  
Pressione max di esercizio: 16 bar  
Filettature: femmina ISO 228 (cilindrica)  
maschio ISO 228 (cilindrica)

#### Technical Features

Maximum temperature: 110°C  
Minimum temperature: -20°C  
Maximum operating pressure: 16 bar  
Threads: female ISO 228 (parallel)  
male ISO 228 (parallel)

#### Descrizione

Corpo  
Vitone  
O-rings  
Guarnizione  
Manopola  
Dischetto segna utenza

#### Materiale

Ottone CW617N - EN12165  
Ottone CW614N - EN12164  
Gomma etilene-propilene EPDM  
Gomma etilene-propilene EPDM  
ABS bianca  
ABS rosso/blu

#### Trattamento

Cromato  
-  
-  
-  
-

#### Description

Body  
Head screw  
O-rings  
Washer  
Handle  
Diskette marks use

#### Material

CW617N-EN12165 brass  
CW614N-EN12164 brass  
Etilene-propylene rubber EPDM  
Etilene-propylene rubber EPDM  
ABS white  
ABS red/blue

#### Treatment

Chrome plated  
-  
-  
-  
-  
-



TIEMME Raccorderie S.p.A.  
Via Cavallera 6/A (Loc. Barco) - 25045 Castegnato (Bs) - Italy  
Tel +39 030 2142211 R.A. - Fax +39 030 2142206  
info@tiemme.com - www.tiemme.com  
©TIEMME Raccorderie S.p.A. MAXIMA Rev. G 04-12



TIEMME Raccorderie S.p.A. si riserva di apportare modifiche in qualsiasi momento senza preavviso.  
TIEMME Raccorderie S.p.A. reserves the right to modify contents in any time without prior advise.  
E' vietata qualsiasi forma di riproduzione, se non autorizzata.  
Is forbidden any reproduction unless under TIEMME autorization





# TIEMME

## COLLETTORI CON RUBINETTO Manifolds with stop cocks

### Serie MAXIMA



Tabella dimensioni / Sizes table

| Size M / F | Vie / Ways | A    | B  | C         | D  | E  | E 1  | F    | G    | H     | I    | L  | Ø  | Ch | Codice / Code |
|------------|------------|------|----|-----------|----|----|------|------|------|-------|------|----|----|----|---------------|
| 3/4"       | 2          | 3/4" | 36 | 12"       | 16 | 13 | 15   | 27,5 | 24   | 87,5  | 39   | 44 | 28 | 32 | 1866K160402   |
|            | 3          | 3/4" | 36 | 12"       | 16 | 13 | 15   | 27,5 | 24   | 123,5 | 39   | 44 | 28 | 32 | 1866K160403   |
|            | 4          | 3/4" | 36 | 12"       | 16 | 13 | 15   | 27,5 | 24   | 159,5 | 39   | 44 | 28 | 32 | 1866K160404   |
|            | 5          | 3/4" | 36 | 12"       | 16 | 13 | 15   | 27,5 | 24   | 195,5 | 39   | 44 | 28 | 32 | 1866K160405   |
| 1"         | 2          | 1"   | 36 | 12"       | 16 | 13 | 15,5 | 29   | 25,5 | 90,5  | 40   | 45 | 33 | 38 | 1868K160402   |
|            | 3          | 1"   | 36 | 12"       | 16 | 13 | 15,5 | 29   | 25,5 | 126,5 | 40   | 45 | 33 | 38 | 1868K160403   |
|            | 4          | 1"   | 36 | 12"       | 16 | 13 | 15,5 | 29   | 25,5 | 162,5 | 40   | 45 | 33 | 38 | 1868K160404   |
|            | 5          | 1"   | 36 | 12"       | 16 | 13 | 15,5 | 29   | 25,5 | 198,5 | 40   | 45 | 33 | 38 | 1868K160405   |
| 3/4"       | 2          | 3/4" | 36 | 24x19 fil | 18 | 13 | 15   | 27,5 | 24   | 87,5  | 37   | 44 | 28 | 32 | 1877K36051902 |
|            | 3          | 3/4" | 36 | 24x19 fil | 18 | 13 | 15   | 27,5 | 24   | 123,5 | 37   | 44 | 28 | 32 | 1877K36051903 |
|            | 4          | 3/4" | 36 | 24x19 fil | 18 | 13 | 15   | 27,5 | 24   | 159,5 | 37   | 44 | 28 | 32 | 1877K36051904 |
|            | 5          | 3/4" | 36 | 24x19 fil | 18 | 13 | 15   | 27,5 | 24   | 195,5 | 37   | 44 | 28 | 32 | 1877K36051905 |
| 1"         | 2          | 1"   | 36 | 24x19 fil | 18 | 13 | 15,5 | 29   | 25,5 | 90,5  | 39   | 45 | 33 | 38 | 1877K36061902 |
|            | 3          | 1"   | 36 | 24x19 fil | 18 | 13 | 15,5 | 29   | 25,5 | 126,5 | 39   | 45 | 33 | 38 | 1877K36061903 |
|            | 4          | 1"   | 36 | 24x19 fil | 18 | 13 | 15,5 | 29   | 25,5 | 162,5 | 39   | 45 | 33 | 38 | 1877K36061904 |
|            | 5          | 1"   | 36 | 24x19 fil | 18 | 13 | 15,5 | 29   | 25,5 | 198,5 | 39   | 45 | 33 | 38 | 1877K36061905 |
| 3/4"       | 2          | 3/4" | 50 | 3/4"      | 18 | 13 | 15   | 32   | 31   | 113,0 | 38   | 44 | 28 | 32 | 1877K50050502 |
|            | 3          | 3/4" | 50 | 3/4"      | 18 | 13 | 15   | 32   | 31   | 163,0 | 38   | 44 | 28 | 32 | 1877K50050503 |
|            | 4          | 3/4" | 50 | 3/4"      | 18 | 13 | 15   | 32   | 31   | 213,0 | 38   | 44 | 28 | 32 | 1877K50050504 |
| 1"         | 2          | 1"   | 50 | 3/4"      | 18 | 13 | 15,5 | 32   | 31   | 113,0 | 39,5 | 45 | 33 | 38 | 1877K50060502 |
|            | 3          | 1"   | 50 | 3/4"      | 18 | 13 | 15,5 | 32   | 31   | 163,0 | 39,5 | 45 | 33 | 38 | 1877K50060503 |
|            | 4          | 1"   | 50 | 3/4"      | 18 | 13 | 15,5 | 32   | 31   | 213,0 | 39,5 | 45 | 33 | 38 | 1877K50060504 |
| 3/4"       | 2          | 3/4" | 50 | 24x19 fil | 18 | 13 | 15   | 32   | 31   | 113,0 | 37   | 44 | 28 | 32 | 1877K50051902 |
|            | 3          | 3/4" | 50 | 24x19 fil | 18 | 13 | 15   | 32   | 31   | 163,0 | 37   | 44 | 28 | 32 | 1877K50051903 |
|            | 4          | 3/4" | 50 | 24x19 fil | 18 | 13 | 15   | 32   | 31   | 213,0 | 37   | 44 | 28 | 32 | 1877K50051904 |
| 1"         | 2          | 1"   | 50 | 24x19 fil | 18 | 13 | 15,5 | 32   | 31   | 113,0 | 39   | 45 | 33 | 38 | 1877K50061902 |
|            | 3          | 1"   | 50 | 24x19 fil | 18 | 13 | 15,5 | 32   | 31   | 163,0 | 39   | 45 | 33 | 38 | 1877K50061903 |
|            | 4          | 1"   | 50 | 24x19 fil | 18 | 13 | 15,5 | 32   | 31   | 213,0 | 39   | 45 | 33 | 38 | 1877K50061904 |

TIEMME Raccorderie S.p.A. si riserva di apportare modifiche in qualsiasi momento senza preavviso.  
TIEMME Raccorderie S.p.A. reserves the right to modify contents in any time without prior advise.  
È vietata qualsiasi forma di riproduzione, se non autorizzata.  
is forbidden any reproduction unless under TIEMME authorization

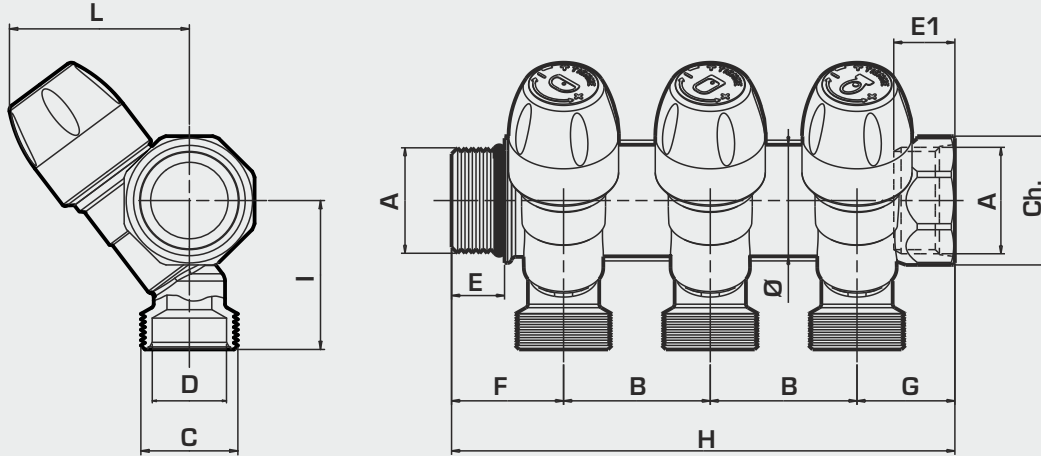

TIEMME Raccorderie S.p.A.  
Via Cavallera 6/A (Loc. Barco) - 25045 Castegnato (Bs) - Italy  
Tel +39 030 2142211 R.A. - Fax +39 030 2142206  
info@tiemme.com - www.tiemme.com  
©TIEMME Raccorderie S.p.A. MAXIMA Rev. G 04-12





# TIEMME

## COLLETTORI CON RUBINETTO

### Manifolds with stop cocks

## Serie MAXIMA

Diagramma portata/perdita di carico - Flow/pressure drop diagram

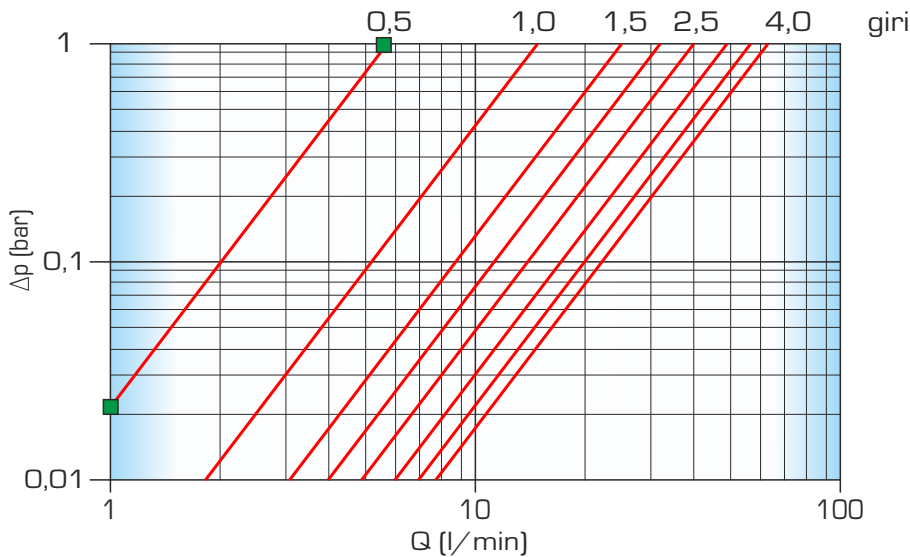

|                  |    |      |
|------------------|----|------|
| 0,5 giri / turns | Kv | 0,34 |
| 1,0 giri / turns | Kv | 0,91 |
| 1,5 giri / turns | Kv | 1,44 |
| 2,0 giri / turns | Kv | 1,91 |
| 2,5 giri / turns | Kv | 2,40 |
| 3,0 giri / turns | Kv | 2,89 |
| 3,5 giri / turns | Kv | 3,33 |
| 4,0 giri / turns | Kv | 3,78 |

### Collettore interasse 36mm con derivazioni 1/2"x16 (1866K-1868K)

Manifold with 1/2"x16 outlets and distance between axis of 36mm (1866K-1868K)

### Guida alle connessioni

#### Fitting guide



Dischetti segna utenza  
Diskette marks use

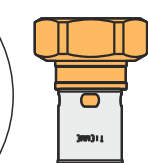
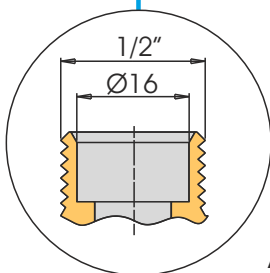
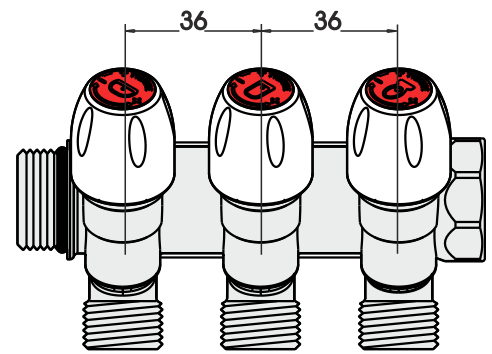
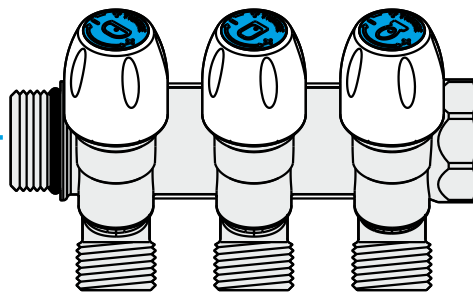
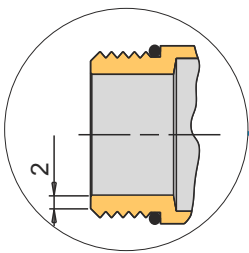

**Art. 1716**  
Per tubo Pe-x  
For Pe-x pipe

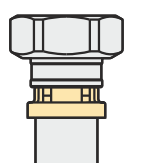

**Art. 1668K**  
Per tubo multistrato  
For multilayer pipe



**Art. 1635K**  
Per tubo multistrato  
For multilayer pipe

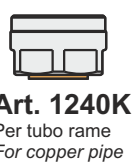

**Art. 1240K**  
Per tubo rame  
For copper pipe

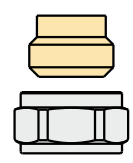

**Art. 1233K**  
**Art. 1235K**  
Per tubo rame  
For copper pipe

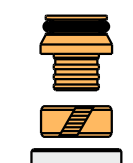

**Art. 1435K**  
Per tubo Pe-x  
For Pe-x pipe

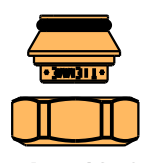

**Art. 1879G0004**  
Tappo  
Cap



TIEMME Raccorderie S.p.A.  
Via Cavallera 6/A (Loc. Barco) - 25045 Castegnato (Bs) - Italy  
Tel +39 030 2142211 R.A. - Fax +39 030 2142206  
info@tiemme.com - www.tiemme.com

©TIEMME Raccorderie S.p.A. MAXIMA Rev. G 04-12







# TIEMME

## COLLETTORI CON RUBINETTO Manifolds with stop cocks

### Serie **MAXIMA**

**Collettore interasse 36mm con derivazioni 24x19fil-18 (1877K36)**

**Manifold with 24x19fil-18 outlets and distance between axis of 36mm (1877K36)**

Guida alle connessioni / *Fitting guide*

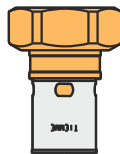
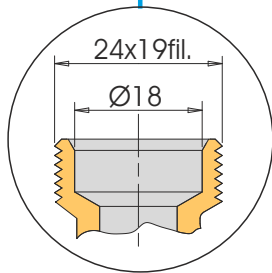
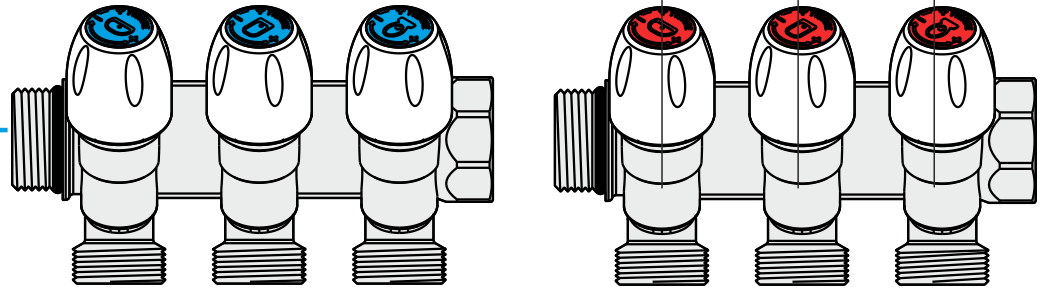
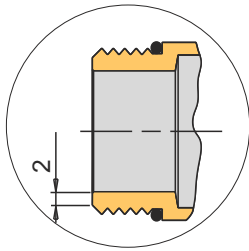

**Art. 1716**  
Per tubo Pe-x  
For Pe-x pipe

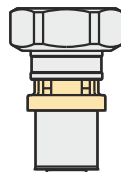

**Art. 1666K**  
Per tubo multistrato  
For multilayer pipe



**Art. 1633K**  
Per tubo multistrato  
For multilayer pipe



**Art. 1243K**  
Per tubo rame  
For copper pipe



**Art. 1433K**  
Per tubo Pe-x  
For Pe-x pipe

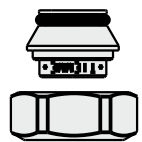

**Art. 1879K2419**  
Tappo  
Cap

**Collettore interasse 50mm con derivazioni 3/4"x18 Eurocono (1877K5005)**

**Manifold with 3/4"x18 Euroconus outlets and distance between axis of 50mm (1877K5005)**

Guida alle connessioni / *Fitting guide*

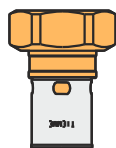
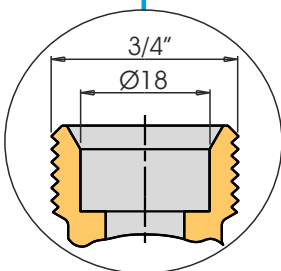
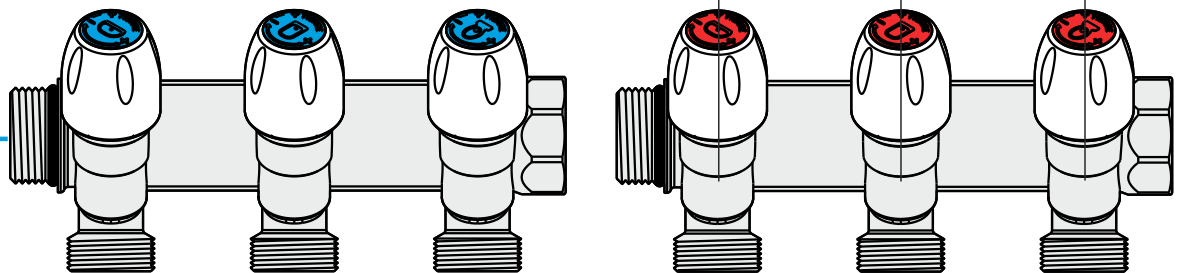
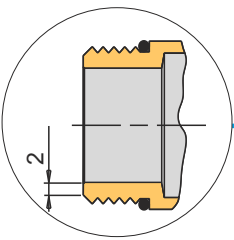

**Art. 1716**  
Per tubo Pe-x  
For Pe-x pipe

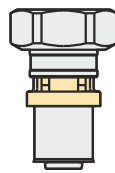

**Art. 1666K**  
Per tubo multistrato  
For multilayer pipe



**Art. 1636K**  
Per tubo multistrato  
For multilayer pipe

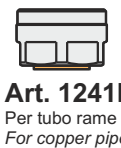

**Art. 1241K**  
Per tubo rame  
For copper pipe



**Art. 1436K**  
Per tubo Pe-x  
For Pe-x pipe

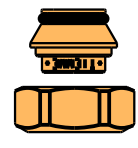

**Art. 1879G0005**  
Tappo  
Cap

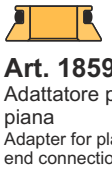

**Art. 1859G0005**  
Adattatore per sede  
piana  
Adapter for plain  
end connection



TIEMME Raccorderie S.p.A.  
Via Cavallera 6/A (Loc. Barco) - 25045 Castegnato (Bs) - Italy  
Tel +39 030 2142211 R.A. - Fax +39 030 2142206  
info@tiemme.com - www.tiemme.com  
©TIEMME Raccorderie S.p.A. MAXIMA Rev. G 04-12



TIEMME Raccorderie S.p.A. si riserva di apportare modifiche in qualsiasi momento senza preavviso.  
TIEMME Raccorderie S.p.A. reserves the right to modify contents in any time without prior advise.  
È vietata qualsiasi forma di riproduzione, se non autorizzata.  
is forbidden any reproduction unless under TIEMME autorization





# TIEMME

## COLLETTORI CON RUBINETTO Manifolds with stop cocks

### Serie **MAXIMA**

Collettore interasse 50mm con derivazioni 24x19fil-18 (1877K5019)

Manifold with 24x19fil-18 outlets and distance between axis of 50mm (1877K5019)

Guida alle connessioni / Fitting guide

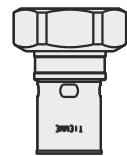
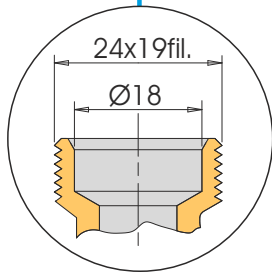
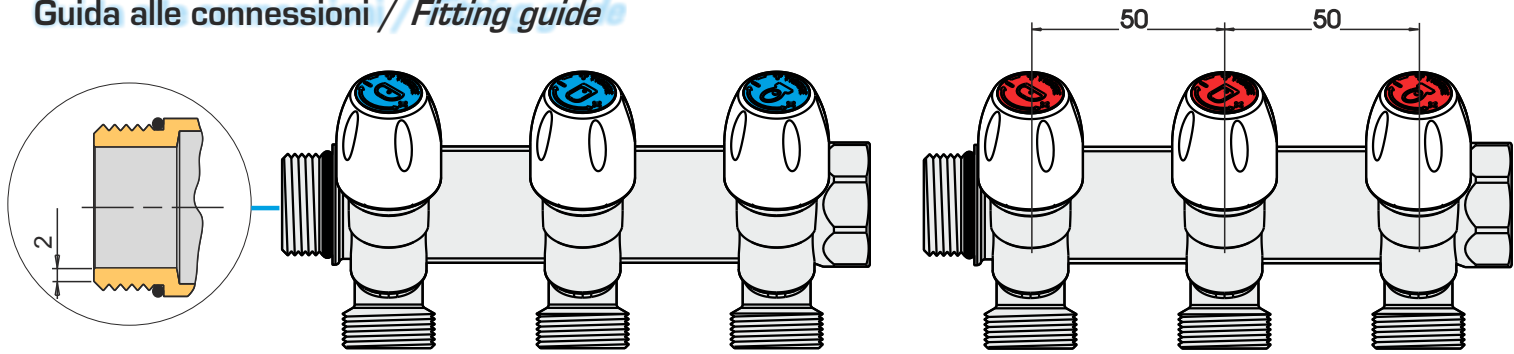

**Art. 1715**  
Per tubo Pe-x  
For Pe-x pipe

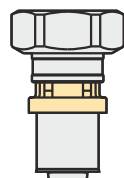

**Art. 1666K**  
Per tubo multistrato  
For multilayer pipe



**Art. 1633K**  
Per tubo multistrato  
For multilayer pipe



**Art. 1243K**  
Per tubo rame  
For copper pipe



**Art. 1433K**  
Per tubo Pe-x  
For Pe-x pipe

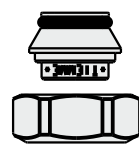

**Art. 1879K2419**  
Tappo  
Cap

### Esempio di accoppiamento collettori con filettatura maschio/femmina fasata Example of connection for manifolds with male/female self-seal thread

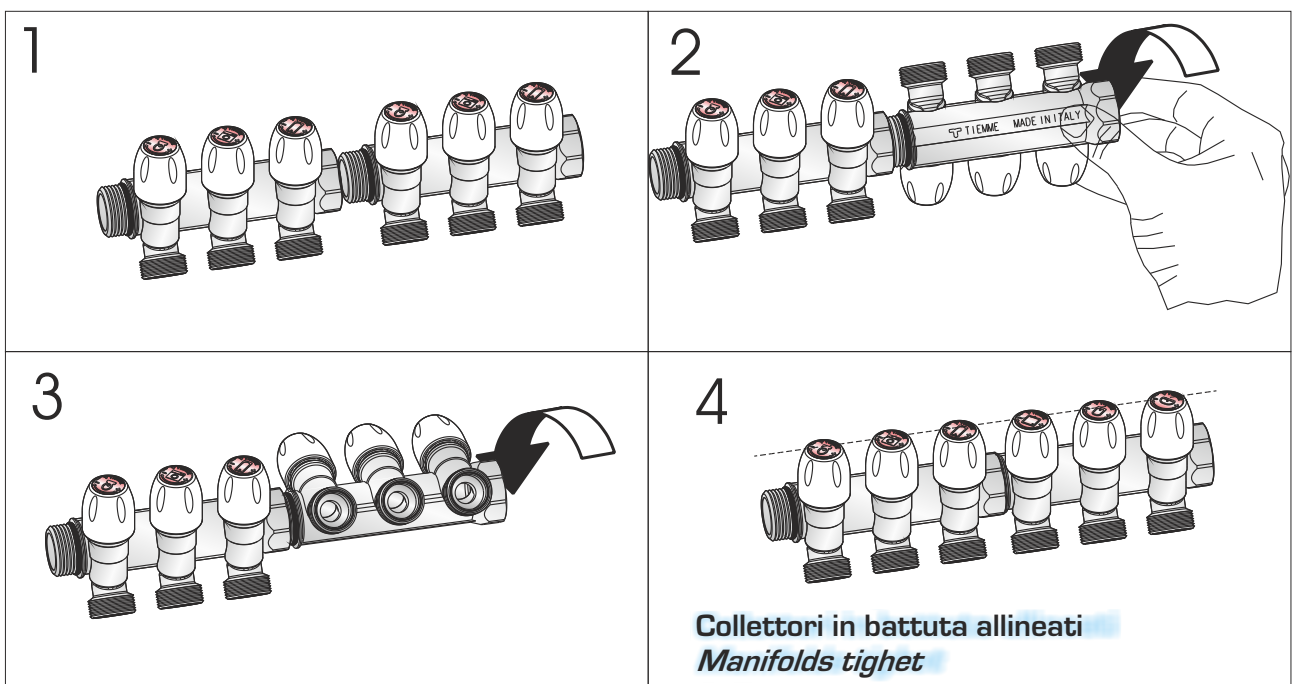

TIEMME Raccorderie S.p.A. si riserva di apportare modifiche in qualsiasi momento senza preavviso.  
TIEMME Raccorderie S.p.A. reserves the right to modify contents in any time without prior advise.  
È vietata qualsiasi forma di riproduzione, se non autorizzata.  
is forbidden any reproduction unless under TIEMME autorization



TIEMME Raccorderie S.p.A.  
Via Cavallera 6/A (Loc. Barco) - 25045 Castegnato (Bs) - Italy  
Tel +39 030 2142211 R.A. - Fax +39 030 2142206  
info@tiemme.com - www.tiemme.com  
©TIEMME Raccorderie S.p.A. MAXIMA Rev. G 04-12





# TIEMME

## COLLETTORI CON RUBINETTO Manifolds with stop cocks

### Serie MAXIMA

Cassette utilizzabili  
Boxes used

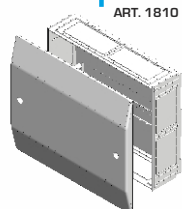
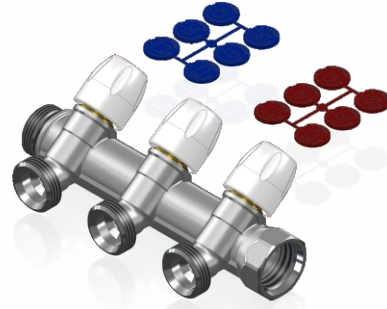
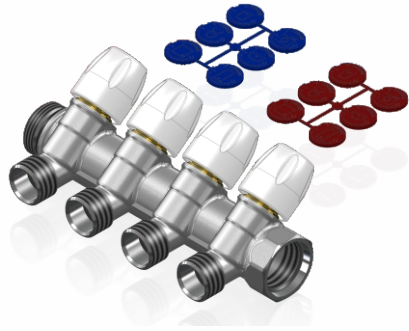

ART. 1810

Cassetta universale  
Universal box

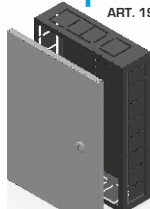

ART. 1920-1930

Cassetta universale  
in metallo  
Universal metallic box

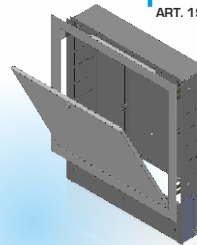

ART. 1939/1940

Cassetta regolabile in  
altezza e profondità  
Metallic box with height and  
depth adjustable

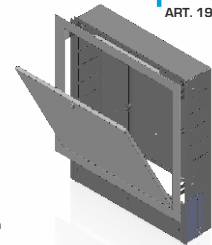

ART. 1939/1940

Cassetta regolabile  
in altezza e  
profondità  
Metallic box with  
height and  
depth adjustable



ART. 1807



Supporti per collettori  
Holding set for manifolds

ART. 1807

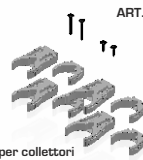

Supporti per collettori  
Holding set for manifolds

ART. 1877SKIT



Kit di fissaggio  
per collettori  
Manifolds bracket

ART. 1870



Supporto per collettori  
Holding set for manifolds



TIEMME Raccorderie S.p.A. si riserva di apportare modifiche in qualsiasi momento senza preavviso.  
TIEMME Raccorderie S.p.A. reserves the right to modify contents in any time without prior advise.  
È vietata qualsiasi forma di riproduzione, se non autorizzata.  
is forbidden any reproduction unless under TIEMME autorization



TIEMME Raccorderie S.p.A.  
Via Cavallera 6/A (Loc. Barco) - 25045 Castegnato (Bs) - Italy  
Tel +39 030 2142211 R.A. - Fax +39 030 2142206  
info@tiemme.com - www.tiemme.com

©TIEMME Raccorderie S.p.A. MAXIMA Rev. G 04-12

