



TIEMME

COLLETTORI CON RUBINETTO

Manifolds with stop cocks

Serie RUBINO

Collettori lineari componibili con derivazioni dotate di rubinetto di chiusura.
Disponibile con 2, 3, 4 o 5 attacchi.

Modular linear manifolds with ways provided of stop cocks.
Available with 2, 3, 4 or 5 pipe connections.

I collettori di distribuzione "RUBINO" sono generalmente utilizzati nelle reti di distribuzione di acqua calda e fredda. Grazie alla loro configurazione permettono l'alimentazione in parallelo delle utenze per acqua calda e/o fredda riducendo al minimo le perdite di carico. I collettori sono prodotti in conformità alle normative in materia e sono certificati relativamente alla composizione chimica dei materiali impiegati ed a livello dimensionale.

The distribution manifolds "RUBINO" are typically used for hot and cold water distribution. Due to the configuration they may be used to distribute cold/hot water in parallel reducing at minimum the pressure drop. The manifolds are produced according to the relevant rules and are certified for material chemical composition and dimensional request.



Per la gamma completa vedere il catalogo / For complete range see catalogue

Certificazioni / Certifications

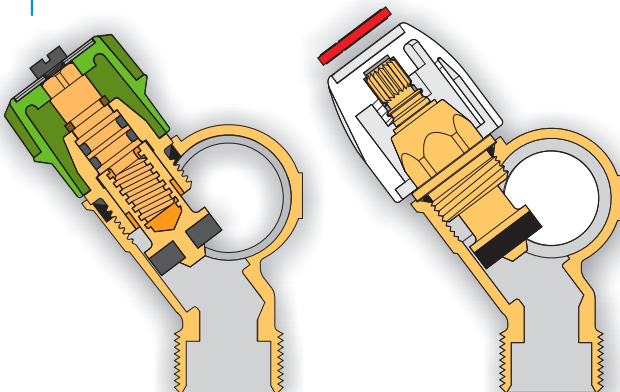

Caratteristiche Tecniche

Temperatura max di esercizio: 110°C
Temperatura min di esercizio: -20°C
Pressione max di esercizio: 16 bar
Filettature: femmina ISO 228 cilindrica
maschio ISO 228 cilindrico

Technical Features

Maximum temperature: 110°C
Minimum temperature: -20°C
Maximum operating pressure: 16 bar
Threads: female ISO 228 parallel
male ISO 228 parallel

Descrizione

Corpo
Vitone
O-rings
Guarnizione
Manopola
Piastrine
Vite
Manopola
Dischetto segna
utenza

Materiale

Ottone CW617N - EN12165
Ottone CW617N - EN12164
Gomma nitrilica NBR
Gomma nitrilica NBR
ABS verde
Alluminio
Acciaio
ABS bianca
ABS rosso/blu

Trattamento

Nichelato
-
-
-
-
-
Brunito

Description

Body
Head screw
O-rings
Washer
Handle
Plaques
Bolt
Handle
Diskette marks use

Material

CW617N-EN12165 brass
CW617N-EN12164 brass
Nitrile Rubber NBR
Nitrile Rubber NBR
ABS green
Aluminium
Steel
ABS white
ABS red/blue

Treatment

Nickel plated
-
-
-
-
-
Burnished



TIEMME Raccorderie S.p.A.
Via Cavallera 6/A (Loc. Barco) - 25045 Castegnato (Bs) - Italy
Tel +39 030 2142211 R.A. - Fax +39 030 2142206
info@tiemme.com - www.tiemme.com





TIEMME

COLLETTORI CON RUBINETTO Manifolds with stop cocks

Serie RUBINO



Tabella dimensioni / Sizes table

Size M/F	Vie/Ways	A	B	I	E	E 1	R	S	L	P	H	Ø	Ch	Codice/Code	Codice/Code
3/4"	2	1/2"	16	36	13	15	27,5	24	87,5	39	43	28	32	1866N160402	184 0003
	3	1/2"	16	36	13	15	27,5	24	123,5	39	43	28	32	1866N160403	184 0002
	4	1/2"	16	36	13	15	27,5	24	159,5	39	43	28	32	1866N160404	184 0001
	5	1/2"	16	36	13	15	27,5	24	195,5	39	43	28	32	1866N160405	184 0008
1"	2	1/2"	16	36	13	15,5	29	25,5	90,5	40	44	33	38	1868N160402	184 0007
	3	1/2"	16	36	13	15,5	29	25,5	126,5	40	44	33	38	1868N160403	184 0005
	4	1/2"	16	36	13	15,5	29	25,5	162,5	40	44	33	38	1868N160404	184 0004
	5	1/2"	16	36	13	15,5	29	25,5	198,5	40	44	33	38	1868N160405	184 0011

Diagramma portata/perdita di carico - Flow/pressure drop diagram

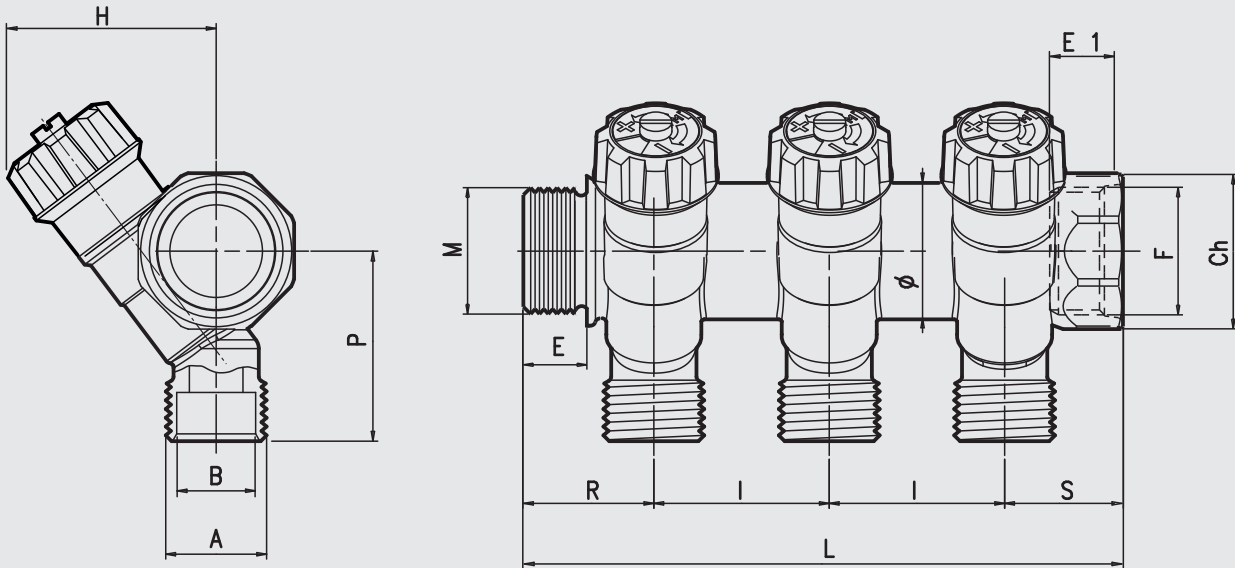
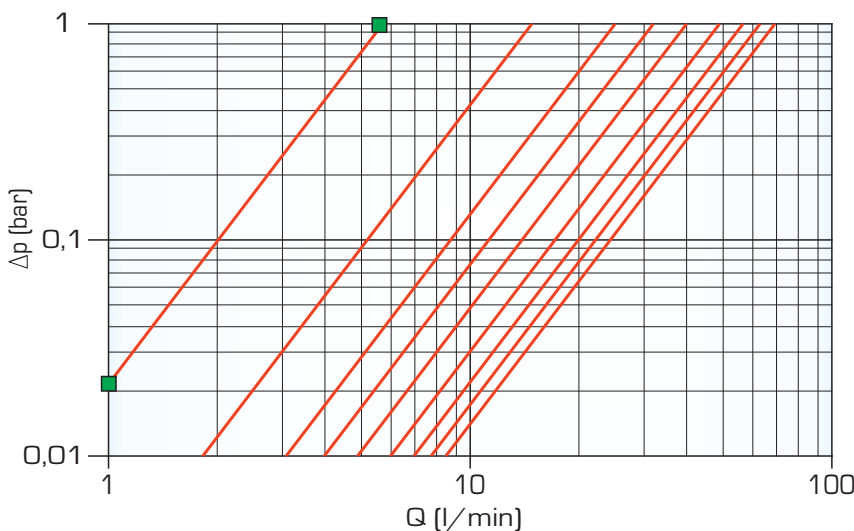

—■—	0,5 giri / turns	Kv	0,34
—	1,0 giri / turns	Kv	0,91
—	1,5 giri / turns	Kv	1,44
—	2,0 giri / turns	Kv	1,91
—	2,5 giri / turns	Kv	2,40
—	3,0 giri / turns	Kv	2,89
—	3,5 giri / turns	Kv	3,33
—	4,0 giri / turns	Kv	3,78
—	4,5 giri / turns	Kv	4,15



TIEMME Raccorderie S.p.A.
Via Cavallera 6/A (Loc. Barco) - 25045 Castegnato (Bs) - Italy
Tel +39 030 2142211 R.A. - Fax +39 030 2142206
info@tiemme.com - www.tiemme.com



TIEMME Raccorderie S.p.A. si riserva di apportare modifiche in qualsiasi momento senza preavviso.
 TIEMME Raccorderie S.p.A. reserves the right to modify contents in any time without prior advise.
 È vietata qualsiasi forma di riproduzione, se non autorizzata.
 is forbidden any reproduction unless under TIEMME autorization



TIEMME

COLLETTORI CON RUBINETTO Manifolds with stop cocks

Serie RUBINO



Tabella dimensioni / Sizes table

Size M/F	Vie/ Ways	A	B	I	E	E1	R	S	L	P	H	Ø	Ch	Codice/ Code
3/4"	2	1/2"	16	36	13	15	27,5	24	87,5	39	44	28	32	184 0030
	3	1/2"	16	36	13	15	27,5	24	123,5	39	44	28	32	184 0031
	4	1/2"	16	36	13	15	27,5	24	159,5	39	44	28	32	184 0032
	5	1/2"	16	36	13	15	27,5	24	195,5	39	44	28	32	184 0033
1"	2	1/2"	16	36	13	15,5	29	25,5	90,5	40	45	33	38	184 0034
	3	1/2"	16	36	13	15,5	29	25,5	126,5	40	45	33	38	184 0035
	4	1/2"	16	36	13	15,5	29	25,5	162,5	40	45	33	38	184 0036
	5	1/2"	16	36	13	15,5	29	25,5	198,5	40	45	33	38	184 0037

Diagramma portata/perdita di carico - Flow/pressure drop diagram

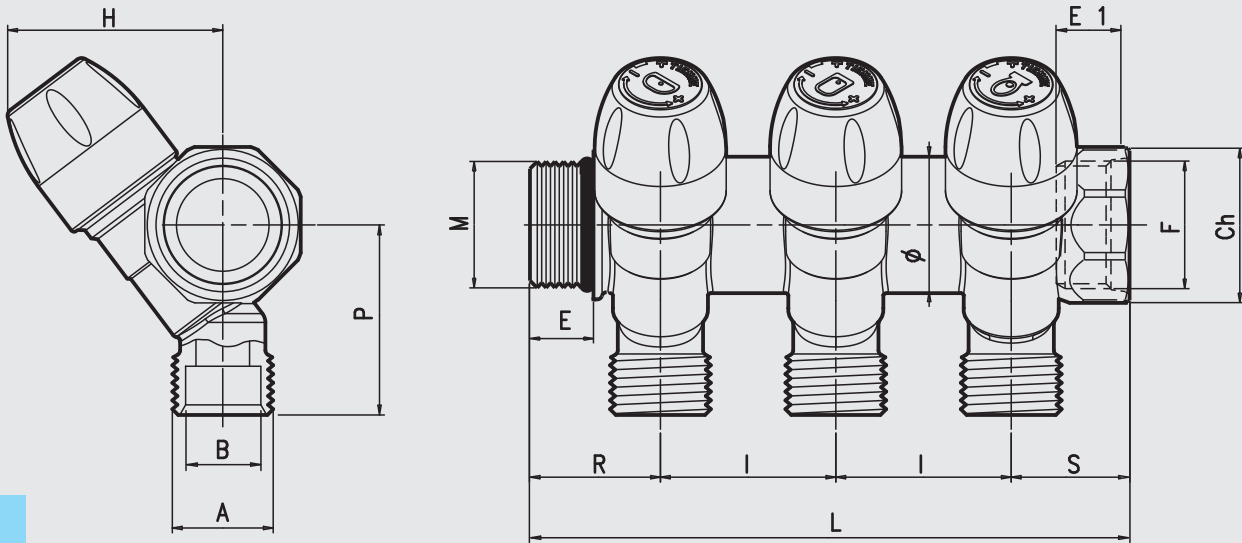
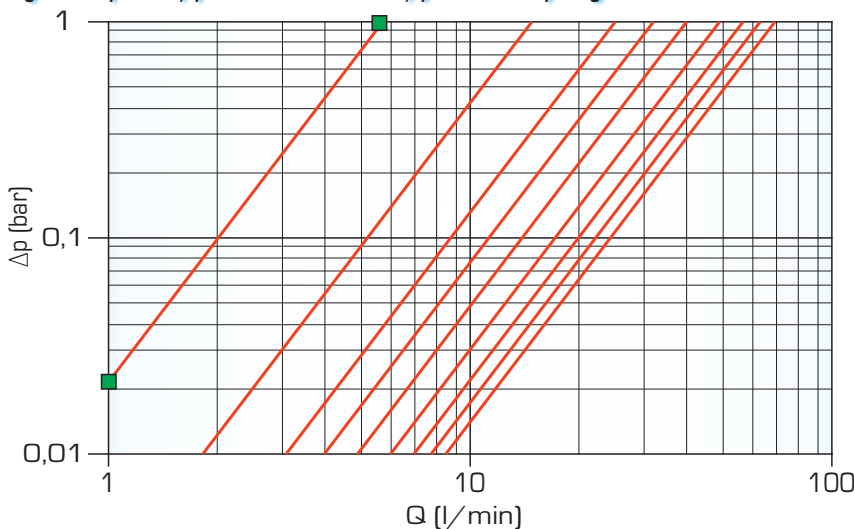

—■—	0,5 giri / turns	Kv	0,34
—	1,0 giri / turns	Kv	0,91
—	1,5 giri / turns	Kv	1,44
—	2,0 giri / turns	Kv	1,91
—	2,5 giri / turns	Kv	2,40
—	3,0 giri / turns	Kv	2,89
—	3,5 giri / turns	Kv	3,33
—	4,0 giri / turns	Kv	3,78
—	4,5 giri / turns	Kv	4,15



TIEMME Raccorderie S.p.A.
Via Cavallera 6/A (Loc. Barco) - 25045 Castegnato (Bs) - Italy
Tel +39 030 2142211 R.A. - Fax +39 030 2142206
info@tiemme.com - www.tiemme.com



TIEMME Raccorderie S.p.A. si riserva di apportare modifiche in qualsiasi momento senza preavviso.
 TIEMME Raccorderie S.p.A. reserves the right to modify contents in any time without prior advise.
 È vietata qualsiasi forma di riproduzione, se non autorizzata.
 is forbidden any reproduction unless under TIEMME autorization





TIEMME

COLLETTORI CON RUBINETTO

Manifolds with stop cocks

Serie RUBINO

Guida alle connessioni
Fitting guide

Art. 1866-1868

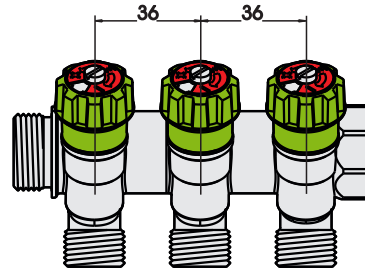
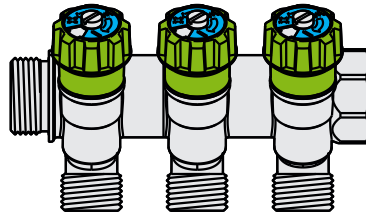
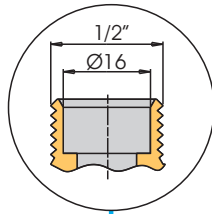

Art. 1716
Per tubo Pe-x
For Pe-x pipe

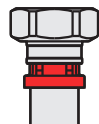

Art. 1668
Per tubo multistrato
For multilayer pipe



Art. 1635
Per tubo multistrato
For multilayer pipe

Art. 1240
Per tubo rame
For copper pipe

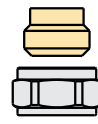

Art. 1233
Art. 1235
Per tubo rame
For copper pipe



Art. 1435
Per tubo Pe-x
For Pe-x pipe

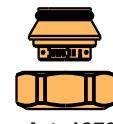

Art. 1879G0004
Tappo
Cap

Cassette utilizzabili
Boxes used

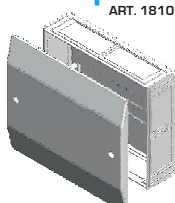
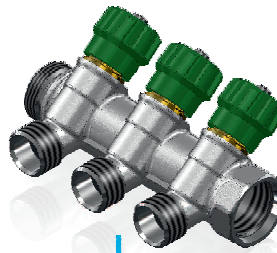

Art. 1810
Cassetta universale
Universal box

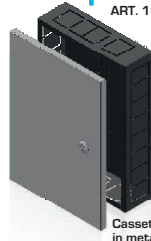

Art. 1920-1930
Cassetta universale
in metallo
Universal metallic box

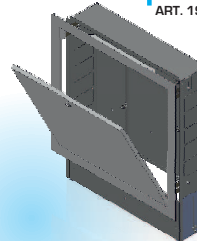

Art. 1939/1940
Cassetta regolabile in
altezza e profondità
Metallic box with height and
depth adjustable

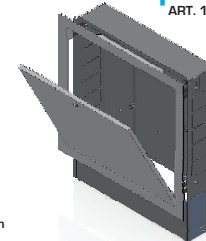

Art. 1939/1940
Cassetta regolabile in
altezza e
profondità
Metallic box with
height and
depth adjustable

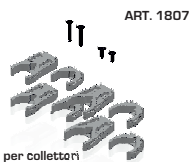

Art. 1807
Supporti per collettori
Holding set for manifolds



Art. 1807
Supporti per collettori
Holding set for manifolds



Art. 1877SKIT
Kit di fissaggio
per collettori
Manifolds bracket



Art. 1870
Supporto per collettori
Holding set for manifolds

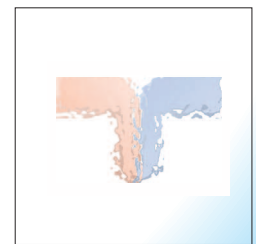
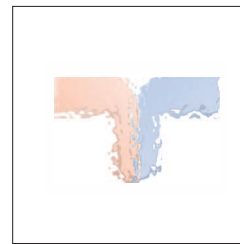
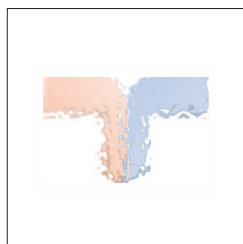
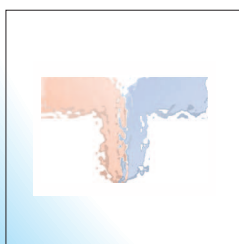

TIEMME Raccorderie S.p.A.
Via Cavallera 6/A (Loc. Barco) - 25045 Castegnato (Bs) - Italy
Tel +39 030 2142211 R.A. - Fax +39 030 2142206
info@tiemme.com - www.tiemme.com



TIEMME Raccorderie S.p.A. si riserva di apportare modifiche in qualsiasi momento senza preavviso.
TIEMME Raccorderie S.p.A. reserves the right to modify contents in any time without prior advise.
È vietata qualsiasi forma di riproduzione, se non autorizzata.
is forbidden any reproduction unless under TIEMME autorization





TIEMME

COLLETTORI CON RUBINETTO

Manifolds with stop cocks

Serie RUBINO

Guida alle connessioni
Fitting guide

Art. 1866-1868

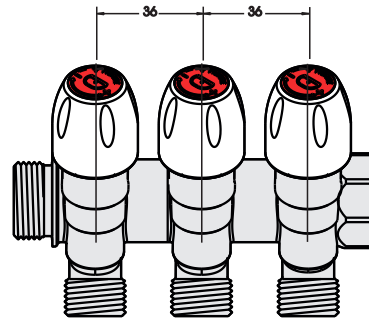
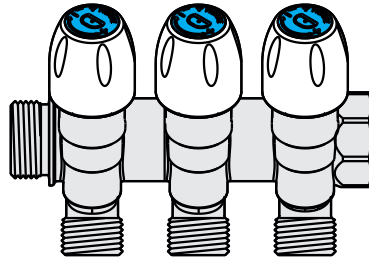
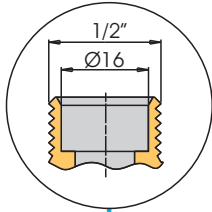

Dischetti segna utenza
Diskette marks use



Art. 1716
Per tubo Pe-x
For Pe-x pipe

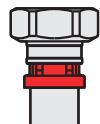

Art. 1668
Per tubo multistrato
For multilayer pipe



Art. 1635
Per tubo multistrato
For multilayer pipe

Art. 1240
Per tubo rame
For copper pipe

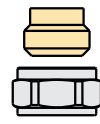

Art. 1233
Art. 1235
Per tubo rame
For copper pipe



Art. 1435
Per tubo Pe-x
For Pe-x pipe

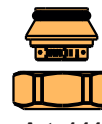

Art. 144 0063
Tappo
Cap

Cassette utilizzabili
Boxes used

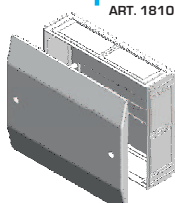

ART. 1810

Cassetta universale
Universal box

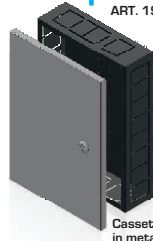

ART. 1920-1930

Cassetta universale
in metallo
Universal metallic box

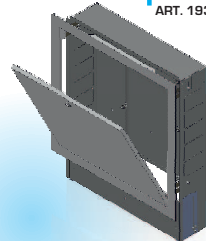

ART. 1939/1940

Cassetta regolabile in
altezza e profondità
Metallic box with height and
depth adjustable

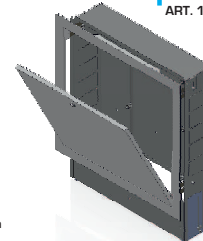

ART. 1939/1940

Cassetta regolabile in
altezza e
profondità
Metallic box with
height and
depth adjustable



ART. 1807

Supporti per collettori
Holding set for manifolds



ART. 1807

Supporti per collettori
Holding set for manifolds



ART. 1877SKIT

Kit di fissaggio
per collettori
Manifolds bracket



ART. 1870

Supporto per collettori
Holding set for manifolds

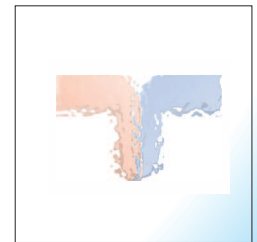
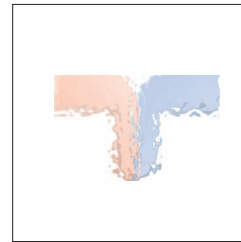
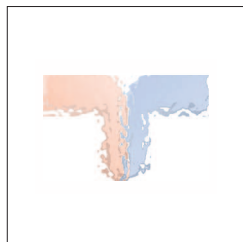
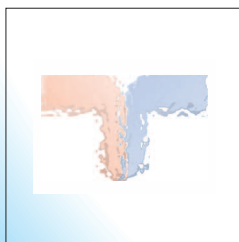

ORIGINAL ITALIAN TRADEMARK

TIEMME Raccorderie S.p.A.
Via Cavallera 6/A (Loc. Barco) - 25045 Castegnato (Bs) - Italy
Tel +39 030 2142211 R.A. - Fax +39 030 2142206
info@tiemme.com - www.tiemme.com



TIEMME Raccorderie S.p.A. si riserva di apportare modifiche in qualsiasi momento senza preavviso.
TIEMME Raccorderie S.p.A. reserves the right to modify contents in any time without prior advise.
È vietata qualsiasi forma di riproduzione, se non autorizzata.
is forbidden any reproduction unless under TIEMME autorization