



# TIEMME

## COLLETTORI LINEARI Linear manifolds

### Serie 1912-1922

Collettori lineari componibili con attacchi 1/2"x16 per tubi rame, tubo PE-X e tubo multistrato.

Disponibile con mandata da 3/4" o 1".

Modular linear manifolds with connections 1/2"x16 for copper, PE-X and multilayer pipes. Available with delivery size 3/4" or 1".



Per la gamma completa vedere il catalogo / For complete range see catalogue

I collettori di distribuzione lineari "Serie 1900" sono generalmente utilizzati nelle reti di distribuzione di acqua calda e fredda. Grazie alla loro configurazione permettono l'alimentazione in parallelo delle utenze per acqua calda e/o fredda riducendo al minimo le perdite di carico. Sono inoltre idonei per l'utilizzo in sistemi a pannelli solari. I collettori sono prodotti in conformità alle normative in materia e sono certificati relativamente alla composizione chimica dei materiali impiegati ed a livello dimensionale.

The distribution linear manifolds "Series 1900" are typically used for hot and cold water distribution. Due to the configuration they may be used to distribute cold/hot water in parallel reducing at minimum the pressure drop. The manifolds are also suitable to be used in solar panel systems. The manifolds are produced according to the relevant rules and are certified for material chemical composition and dimensional request.

#### Caratteristiche Tecniche

Temperatura max di esercizio: 200°C  
Temperatura min di esercizio: -20°C  
Pressione max di esercizio: 16 bar (10 bar con vapore)  
Filettature: femmina ISO 7/1 cilindrico  
maschio ISO 7/1 conico

#### Technical Features

Maximum temperature: 200°C  
Minimum temperature: -20°C  
Maximum operating pressure: 16 bar (10 bar for steam applications)  
Threads: female ISO 7/1 cylindrical  
male ISO 7/1 conical

Descrizione	Materiale	Trattamento
Corpo	Ottone CW617N - EN12165	-

Description	Material	Treatment
Body	CW617N-EN12165 brass	-

Certificazioni / Certifications



TIEMME Raccorderie S.p.A. si riserva di apportare modifiche in qualsiasi momento senza preavviso. TIEMME Raccorderie S.p.A. reserves the right to modify contents in any time without prior advise. È vietata qualsiasi forma di riproduzione, se non autorizzata. Is forbidden any reproduction unless under TIEMME autorization



TIEMME Raccorderie S.p.A.  
Via Cavallera 6/A (Loc. Barco) - 25045 Castegnato (Bs) - Italy  
Tel +39 030 2142211 R.A. - Fax +39 030 2142206  
info@tiemme.com - www.tiemme.com





# TIEMME

## COLLETTORI LINEARI Linear manifolds

### Serie 1912-1922



Tabella dimensioni / Sizes table

Size	Vie/ Ways	A	B	C	D	E	F	G	H	I	Ch.	Codice/ Code
3/4"	2	93,5	3/4"	16,5	16,5	1/2"	16,2	36	27,0	30,5	32	1912G050402
	3	129,5	3/4"	16,5	16,5	1/2"	16,2	36	27,0	30,5	32	1913G050403
	4	165,5	3/4"	16,5	16,5	1/2"	16,2	36	27,0	30,5	32	1914G050404
	5	201,5	3/4"	16,5	16,5	1/2"	16,2	36	27,0	30,5	32	1915G050405
1"	2	94,5	1"	17,0	17,0	1/2"	16,2	36	27,5	31,0	38	1922G060402
	3	130,5	1"	17,0	17,0	1/2"	16,2	36	27,5	31,0	38	1923G060403
	4	166,5	1"	17,0	17,0	1/2"	16,2	36	27,5	31,0	38	1924G060404
	5	202,5	1"	17,0	17,0	1/2"	16,2	36	27,5	31,0	38	1925G060405

Guida alle connessioni / Fitting guide

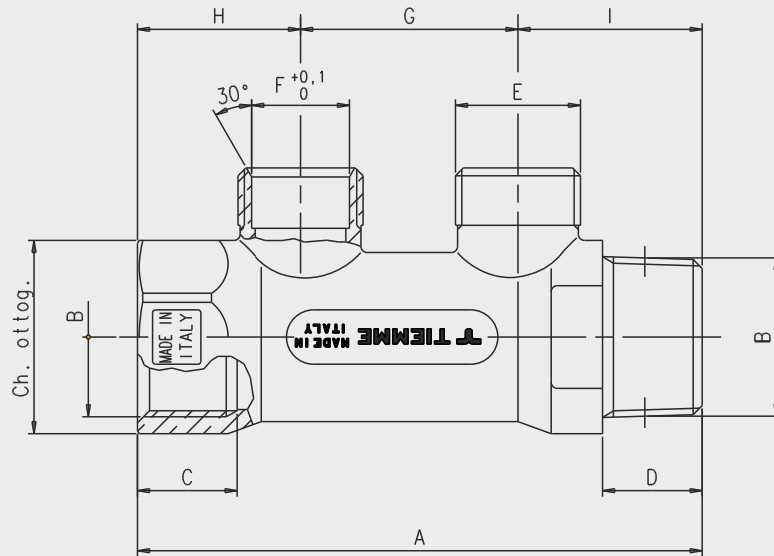
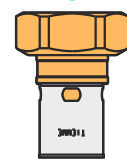
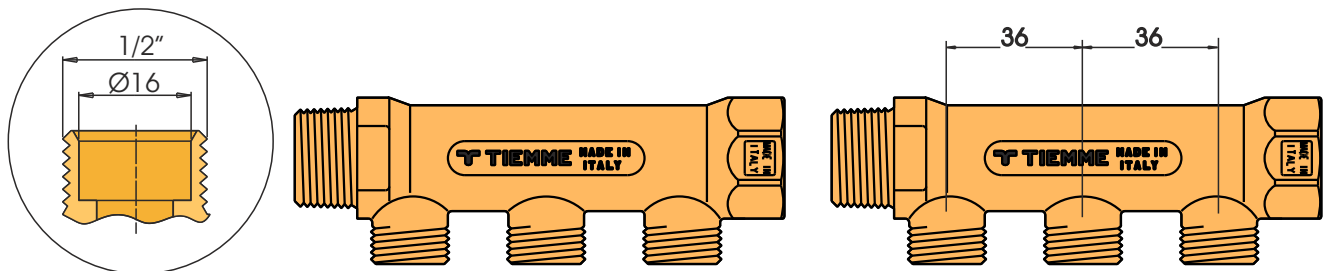

**Art. 1716**  
Per tubo Pe-x  
For Pe-x pipe

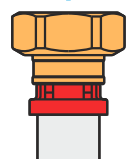

**Art. 1668**  
Per tubo multistrato  
For multilayer pipe



**Art. 1635**  
Per tubo multistrato  
For multilayer pipe



**Art. 1240**  
Per tubo rame  
For copper pipe

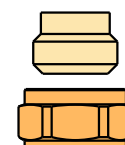

**Art. 1233**  
**Art. 1235**  
Per tubo rame  
For copper pipe



**Art. 1435**  
Per tubo Pe-x  
For Pe-x pipe

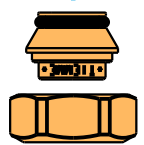

**Art. 1879G0004**  
Tappo  
Cap



**TIEMME Raccorderie S.p.A.**  
Via Cavallera 6/A (Loc. Barco) - 25045 Castegnato (Bs) - Italy  
Tel +39 030 2142211 R.A. - Fax +39 030 2142206  
info@tiemme.com - www.tiemme.com



TIEMME Raccorderie S.p.A. si riserva di apportare modifiche in qualsiasi momento senza preavviso.  
TIEMME Raccorderie S.p.A. reserves the right to modify contents in any time without prior advise.  
È vietata qualsiasi forma di riproduzione, se non autorizzata.  
is forbidden any reproduction unless under TIEMME autorization





# TIEMME

## COLLETTORI LINEARI Linear manifolds

### Serie 1912-1922

Cassette utilizzabili  
Boxes used



ART. 1939/1940

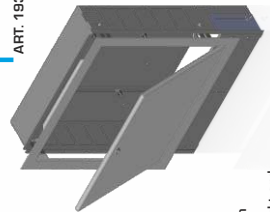

Cassetta regolabile in altezza e profondità  
Metallic box with height and depth adjustable

ART. 1870



Supporto per collettori  
Holding set for manifolds

ART. 1939/1940

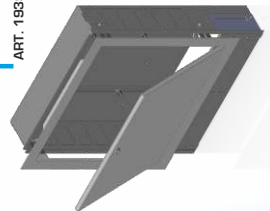

Cassetta regolabile in altezza e profondità  
Metallic box with height and depth adjustable

ART. 1877SKIT



Kit di fissaggio per collettori  
Manifolds bracket

ART. 1920-1930

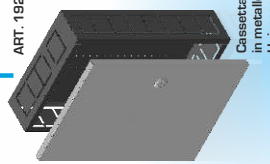

Cassetta universale in metallo  
Universal metallic box

ART. 1807

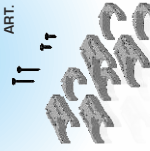

Supporto per collettori  
Holding set for manifolds

ART. 1810

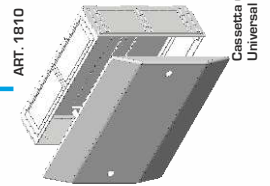

Cassetta universale  
Universal box

ART. 1807

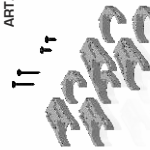

Supporto per collettori  
Holding set for manifolds

ART. 1910P



Cassetta universale «JOLLY»  
«JOLLY» Universal box

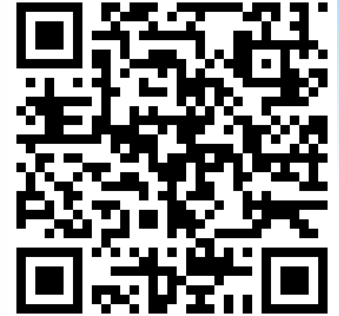

TIEMME Raccorderie S.p.A. si riserva di apportare modifiche in qualsiasi momento senza preavviso.  
TIEMME Raccorderie S.p.A. reserves the right to modify contents in any time without prior advise.  
È vietata qualsiasi forma di riproduzione, se non autorizzata.  
is forbidden any reproduction unless under TIEMME autorization



TIEMME Raccorderie S.p.A.  
Via Cavallera 6/A (Loc. Barco) - 25045 Castegnato (Bs) - Italy  
Tel +39 030 2142211 R.A. - Fax +39 030 2142206  
info@tiemme.com - www.tiemme.com

